

PRODUCT SELECTION DATA



- Packaged unit all in one
 - High efficiency
 - Silent operation
- Configuration flexibility
- Ductable feature for indoor installation

Ductable air-cooled scroll chillers and heat pumps

30PA/PH/PAC/PHC 90-180



CARRIER participates in the ECP programme for RT
Check ongoing validity of certificate:
www.eurovent-certification.com
www.certiflash.com





Ductable air-cooled scroll chillers and heat pumps

Contents

Description.....	3
Series	3
Range.....	3
Operation limits.....	3
Unit components.....	4
Casing.....	4
Outdoor circuit.....	4
Cooling circuit.....	4
Indoor circuit.....	4
Version with circulation pump included (30PAC/PHC).....	4
Protections	4
Electric panel.....	4
30PA/PH electronic control.....	5
Sound levels: Unit sound power level and sound pressure level	5
Options	6
STD version: technical characteristics.....	7
STD version: technical characteristics with pump included 30PAC/PHC.....	8
Graphs of pressure drops in STD version	8
HEE version: technical characteristics	9
HEE version: technical characteristics with pump included 30PAC/PHC	10
Graphs of pressure drops in HEE version	10
Schematic diagram of the hydraulic circuit.....	11
Circulation pumps available for 30PAC/PHC	11
Pressure drops in the mesh filter (sent in the kit)	12
Minimum volume of water admissible in the installation (cooling mode).....	12
Cooling capacity of the STD version (kW).....	13
Heating capacity of the STD version (kW).....	14
Cooling capacity of the HEE version (kW).....	15
Heating capacity of the HEE version (kW)	16
Evaporator operating limits.....	17
Operation with glycol water	17
Corrosion behaviour	18
Cooling recovery circuit (optional)	19
Technical characteristics of the recovery circuit	20
Capacity recovered by the recovery circuit with the STD version	21
Capacity recovered by the recovery circuit with the HEE version.....	22
Dimension schemes for the STD version	23
Dimension schemes for the HEE version	28
Dimensions of air flexible ducts (option).....	34
Gravimetric filters in the return air (option).....	35
Airflow characteristics: selection of fan motors.....	36
Assembly recommendations	37
Lifting and handling operations	37
Location.....	37
Safety devices.....	37
Electrical connections	37
Water quality criteria	37
Hydraulic connections	38
Hydraulic circuit.....	38
Commissioning.....	38
Problems in commissioning	38



Ductable air-cooled scroll chillers and heat pumps



DESCRIPTION

The **30PA/PH** cooling only and reversible heat pumps are compact outdoor air/water units. Available in two versions: **STD (Standard)** and **HEE (High Energy Efficiency)**.

These units have been made for operation indoors in the production of hot and/or cold water, applicable to heating, cooling, and industry.

They are equipped with centrifugal fan (STD version) or electronic plug-fan (HEE version), plate exchanger, hermetic scroll compressor, and electronic control with microprocessor, components optimised for the R-410A refrigerant.

This range is also offered with an integrated circulation pump: **30PAC/PHC**.

The entire range also has the option to include a desuperheater circuit that allows for the production of hot water at a temperature greater than in the condensation circuits.

All units are charged with refrigerant and are tested at the factory, verifying the correct operation of all their components.

SERIES

30PA/PAC

Air-cooled water chillers.

30PH/PHC

Reversible heat pump units for operation in negative outdoor temperatures (greater than -15°C WB) for water heating and cooling. Defrosting by reversing the cycle.

RANGE

Models	STD version (Standard)	HEE version (High Energy Efficiency)
1 circuit 1 compressor	90 / 100 / 120 / 160 / 180	90 / 100 / 120 / 160 / 180

OPERATION LIMITS

Series	Cooling mode				Heating mode			
	Air		Water (outlet T.)		Air		Water (outlet T.)	
	Max.	Min.	Max.	Min.	Max.	Min.	Max.	Min.
30PA/PAC	46°C	12°C ①	18°C	5°C ②	--	--	--	--
30PH/PHC	46°C	12°C ①	18°C	5°C ②	20°C DB	-15°C DB	55°C	30°C

① With control of the condensation pressure operating up to -15°C.

② Minimum outlet temperature. With the option of glycol water for lower temperature operation from 5°C to -7°C.

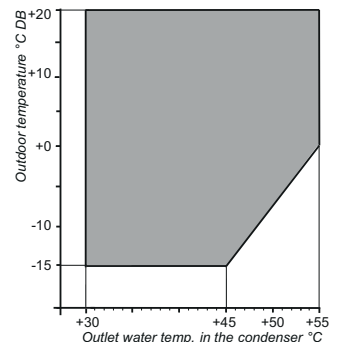
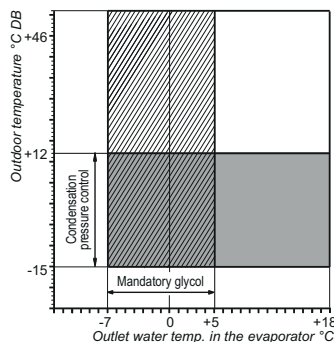

UNIT COMPONENTS

Casing

- Casing made of galvanised steel metal with polyester paint, colour RAL 7035. Self-supporting and isolated frame.

Outdoor circuit

- Coil with copper pipes and aluminium fins.
- Condensate drain pan.
- Choice of air supply position:
 - HORIZONTAL: M00 assembly or VERTICAL: M01 assembly.

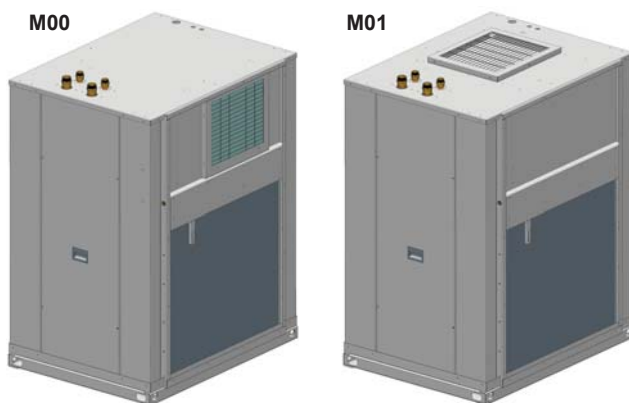

- Supply fan:

STD Version (Standard):

- Centrifugal fan coupling by pulleys and belts.
- Electric motor with tensioner, energy-efficient IE2 motors, class F, IP55, and internal thermal protection.
- One double-intake turbine, with an impeller with front-curved blades. Greased spherical bearings, with no maintenance required.
- Choice of available pressure from 7 to 35 mm.w.c.

HEE Version (High Energy Efficiency):

- Variable speed electronic plug-fan(s) with condensation pressure control which adapt their rotation speed to the installation requirements, thereby reducing electricity consumption, the sound level at partial charge, and improving the average seasonal output of the unit (ESEER).
- Energy-efficient ErP 2015 motor, Class F, IP54, and internal thermal protection.

Cooling circuit

- Hermetic scroll-type compressor, with acoustic insulating cover, assembled over antivibration mounts. Control of phase equilibrium and the direction of rotation.
- Crankcase heater.
- Thermostatic expansion valve with external equalisation.
- Anti-acid dehydrating filter.
- Liquid receiver (heat pump units).
- Four-way cycle reversing valves (heat pump units).

Indoor circuit

- Thermally isolated, welded stainless steel plate exchanger.

Version with circulation pump included (30PAC/PHC)

This version includes, in the same casing that the 30PA/PH version, the following components:

- Monocellular IP55 centrifugal circulation pump that can operate with glycol water (mono-ethylene glycol). The pump must be changed for mono-propylene glycol (upon request).
- Closed expansion vessel.
- Safety valve with a tare value of 4 bar and draining valve.
- Air bleeder valve (model 160HEE and 180HEE).
- Filter with stainless steel mesh (500 microns), supplied in the kit for installation by the installer.

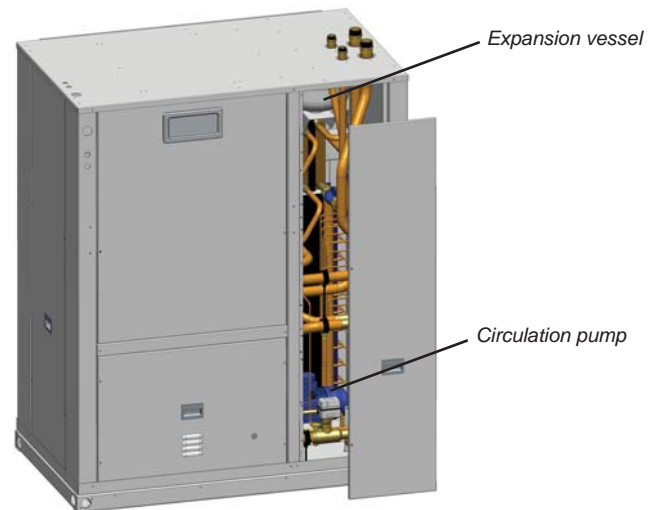

Protections

- High and low pressure pressostats.
- Differential pressure switch for control of water flow.
- Water anti-freeze protection built into the control, depending on the temperature measured by the probe placed on the exchanger outlet.
- Refrigerant anti-freeze protection.
- Compressor discharge temperature control.
- Non-return valve built into the compressor discharge.
- Compressor thermal protection.
- Main door switch.
- Automatic switch in the control circuit.
- Magnetothermic protection switches for the compressor and fan motor power line.
- Timing the disconnection of the circulation pump.
- Failure safety device for the circulation pump.

Electric panel

- Complete and fully wired electric panel. Insulated panel cover to prevent condensation.
- IP55 protection.
- Power supply with neutral and main ground connection.
- Compressor and fan motor contacts.



Ductable air-cooled scroll chillers and heat pumps

30PA/PH ELECTRONIC CONTROL

The **30PA/PH control** I is basically comprised of a μ PC-SMALL control board, a pGD1 graphic terminal, a TCO user terminal (optional for remote control) and sensors.

This control allows the connection to a centralised technical management system by using a specific BMS card for some of the following communication protocols: Carel, Modbus, LonWorks®, BACnet™ MSTP, Konnex, Modbus TCP/IP, BACnet™ Ethernet, TCP/IP, SNMP V1-2-3, FTP and HTTP.

Main functions:

- Control in COOLING / HEATING modes.
- Selection of inlet water temperature setpoints for COOLING / HEATING modes.
- Permanent control and optimization of the operating parameters
- Safety management.
- Timing of the compressor.
- Defrosting management (heat pumps).
- Control of condensation and evaporation pressures.
- Control of outdoor electronic plug-fan (HEE version).
- Control of the circulation pump.
- Regulation of the water outlet temperature.
- Compensation of the setpoint based on the outdoor temperature.
- Timer and weekly programming.
- Failure diagnosis and main alarm.

pGD1 terminal

This graphic terminal, installed on the electric panel of the machine, allows:

- The initial programming of the unit
- Modification of operating parameters.
- Unit ON / OFF.
- Selection of the operating mode.
- Setting of setpoints.
- On-screen display of controlled variables and sensor values measured.
- On-screen display of active alarms and historical record of alarms.



TCO user terminal (optional for remote control):

The TCO user terminal, for remote control, allows:

- Modification of some operating parameters.
- Unit ON / OFF.
- Selection of the operating mode and setting of setpoints.
- On-screen display some controlled variables and probe values.
- On-screen display of alarms codes.



SOUND LEVELS

Unit sound power level

Measurement conditions: ducted discharge and return. For nominal operating conditions EN 14511 – COOLING and HEATING modes.

Acoustic power reference: 10E-12 W, tolerance of ± 2 dB (partial charge of ± 4 dB).

30PA/PH/ PAC/PHC	STD version					HEE version				
	90STD	100STD	120STD	160STD	180STD	90HEE	100HEE	120HEE	160HEE	180HEE
63 Hz dB(lin)	73,8	74,2	74,4	74,4	74,4	71,1	73	73,1	73,1	73,1
125 Hz dB(lin)	73,2	73,6	73,8	73,8	73,8	70,9	72,8	72,9	72,9	72,9
250 Hz dB(lin)	70,2	70,6	70,8	70,8	70,8	67,5	69,4	69,5	69,5	69,5
500 Hz dB(lin)	65,3	65,7	65,9	65,9	65,9	65,4	67,3	67,4	67,4	67,4
1000 Hz dB(lin)	63,0	63,4	63,6	63,6	63,6	62,4	64,3	64,4	64,4	64,4
2000 Hz dB(lin)	62,2	62,6	62,8	62,8	62,8	59,5	61,3	61,5	61,5	61,4
4000 Hz dB(lin)	58,2	58,6	58,8	58,8	58,8	56,5	58,4	58,5	58,5	58,5
8000 Hz dB(lin)	49,3	49,7	49,9	49,9	49,9	49,4	51,3	51,4	51,4	51,4
Total dB(A)	69,4	69,8	70,0	70,0	70,0	68,0	69,9	70,0	70,0	70,0

Note: The unit has acoustic insulating cover for compressor (Low Noise version).

Sound pressure level

Measurement conditions: in a clear field, measured at a distance of 10 metres, directivity 2 and at 1,5 metres from the ground.

30PA/PH/PAC/PHC	STD version					HEE version				
	90STD	100STD	120STD	160STD	180STD	90HEE	100HEE	120HEE	160HEE	180HEE
Total dB(A)	38,0	38,4	38,4	38,4	38,4	36,6	38,3	38,4	38,4	38,4

Note: The sound pressure level depends on the installation conditions and, as such, is only indicated as a guide. Values obtained according to standard ISO 3744.

OPTIONS

Pumps

The pump installed in a unit 30PAC/PHC can be replaced for:

- High-pressure, monocellular, IP55, circulation pump that can operate with glycol water (mono-ethylene glycol).
- Low-pressure, monocellular, IP55, circulation pump that can operate with glycol water (mono-ethylene glycol) (except model 90).

Configuration

- VERTICAL air supply, M01 assembly (default horizontal supply, M00 assembly).
- In the STD version: Different configurations of available pressure from 7 to 35 mm.w.c.

Climatic conditions

- In units with the **STD version** that work in cooling with an outdoor temperature lower than 12°C, the condensation pressure control allowing an "all seasons" operation (up to -15°C) is mandatory. This is performed per motorized damper in the fan outlet.

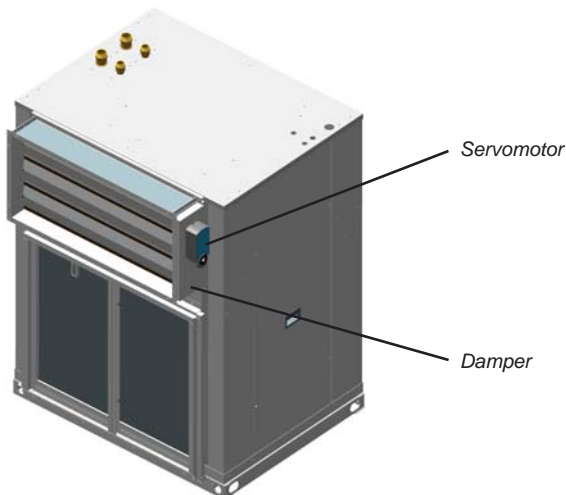

- Coils protection:
 - Coil with copper pipes and copper fins (upon request).
 - Coil with copper pipes and aluminium fins with polyurethane and blygold coating.
- During periods with low outdoor temperatures, anti-freeze protection for the unit:
 - Electrical heaters in the condensate drain pan. Mandatory when outdoor temperatures are below 3°C.
 - Operation with glycol water up to a minimum outlet temperature of -7°C.
 - Anti-freeze protection with flexible electrical heaters around the pipe of the hydraulic circuit.

Installation

- Antivibration mounts made of rubber.
- Protection grille for the coil.
- Gravimetric filters in the return air. The filters frame is removable, and upon request, it is possible to supply the frame independently with the unit, to be joined on site.

- Flexible ducts for supply and return air.
- Flexible hydraulic connections (500mm), supplied in the kit. Available for:
 - Inlet / outlet of the unit.
 - Inlet / outlet of the desuperheater circuit.
- For 30PA/PH units, filter with stainless steel mesh (500 microns), supplied in the kit. Note: this filter is standard for 30PAC/PHC units.
- Cut-off and water control valves, supplied in the kit.
- High-pressure and low-pressure gauges in the cooling circuit.

Energy recovery

Desuperheater circuit which includes:

- Thermally isolated, welded stainless steel plate exchanger for working in a closed circuit in the recovery of hot gases.
- Draining valve and ball valve
- Hot water recovery control thermostat.
- Option for a 3-speed hot water circulation pump.

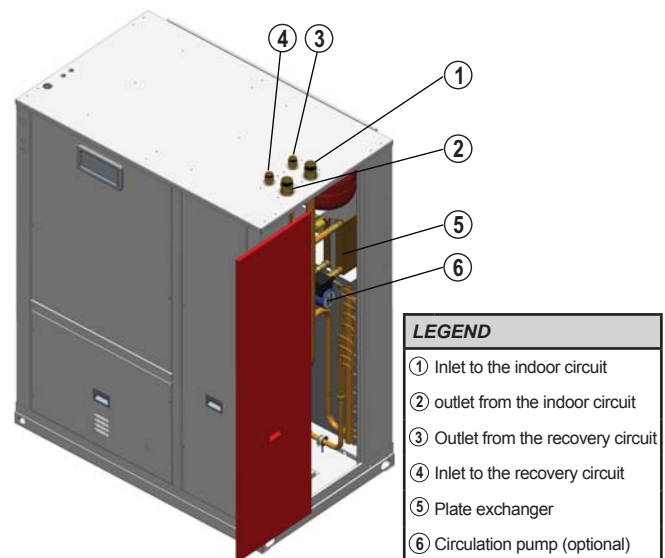

Electric panel

- Compressor soft starter.
- Transformer for power supply without neutral.
- Voltage 400 / 440V - 60 Hz (upon request).
- Energy meter for monitoring of the power consumption of the installation.

Control / communications management

- TCO user terminal, for remote control.
- RS485 serial cards for network communication with protocols: Carel, Modbus, LonWorks®, BACnet™ MSTP, Konnex.
- Ethernet pCO Web card for network communication with protocols: Modbus TCP/IP, BACnet™ Ethernet, TCP/IP, SNMP V1-2-3, FTP and HTTP.



Ductable air-cooled scroll chillers and heat pumps

STD VERSION: TECHNICAL CHARACTERISTICS

30PA/PH		90STD	100STD	120STD	160STD	180STD	
Cooling capacities	Net cooling capacity ① (kW)	17,70	21,10	25,20	32,70	36,00	
	Net power input ③ (kW)	7,75	9,15	10,00	12,60	14,40	
	Net efficiency	EER	2,29	2,31	2,51	2,60	2,49
	Seasonal efficiency	ESEER ④	2,61	2,59	2,81	2,94	2,85
Heating capacities	Net heating capacity ② (kW)	21,80	26,10	29,70	38,30	42,60	
	Net power input ③ (kW)	7,31	8,90	9,90	12,90	14,20	
	Net efficiency	COP	2,97	2,94	3,00	2,97	3,01
	Seasonal efficiency ⑤ Average climate	SCOP	3,11	3,12	3,07	2,95	2,95
		ηs Heat	121%	122%	120%	115%	115%
		Prated (kW)	16,77	19,19	21,82	26,33	31,31
	Seasonal efficiency ⑤ Warmer climate	SCOP	3,59	3,63	3,57	3,42	3,35
		ηs Heat	140%	142%	140%	134%	131%
Prated (kW)		12,73	14,70	16,72	24,30	27,32	
Outdoor circuit centrifugal fan	Nominal air flow (m³/h)	6500	7000	10000	12200	12200	
	Available static pressure (mm.w.c.)	20					
	Number / turbines	1					
	Motor output (kW)	2,2	2,2	3,0	4,0	4,0	
	Power input (kW) ⑥	1,46	1,77	2,33	2,83	2,83	
	Speed (r.p.m.)	973	1027	837	734	734	
Indoor circuit	Nominal water flow (m³/h)	3,1	3,7	4,3	5,7	6,2	
	Pressure drop (m.w.c.)	2,3	3,2	2,9	4,7	2,9	
	Minimum water flow (m³/h)	2,2	2,7	3,1	4,1	4,3	
	Maximum water flow (m³/h)	6,2	7,4	8,8	11,3	12,7	
	Type of hydraulic connections	Gas threaded					
	Diameter of connections	1 1/4" M		1 1/2" M			
Compressor	Type	Scroll					
	Number of compressors / stages / circuits	1 / 1 / 1					
	Oil type	Copeland 3MAF 32 cST, Danfoss POE 160 SZ, ICI Emkarate RL 32 CF, Mobil EAL Artic 22 CC					
	Volume of oil (l)	3,0	3,3	3,3	3,3	6,2	
Refrigerant	Type	R-410A					
	Global warming potential (GWP) ⑦	2.088					
	Charge (kg)	5,9	6,1	6,6	6,9	7,6	
	Environment impact (tCO ₂ e)	12,3	12,7	13,8	14,4	15,9	
Electrical characteristics	Electrical power supply	400 V / III ph / 50 Hz (±10%)					
	Power supply	3 Wires + Ground + Neutral					
Maximum absorbed current	Compressor (A)	15,2	17,3	20,5	25,4	30,5	
	Fan (A)	5,0	5,0	6,9	8,9	8,9	
	Control (A)	0,9	0,9	0,9	0,9	0,9	
	Total (A)	21,1	23,2	28,3	35,2	40,3	
Dimensions	Length (mm)	1117		1398			
	Width (mm)	860		860			
	Height (mm)	1447		1727			
Weight	Empty (kg)	302	310	372	390	388	
	In operation (kg)	306	315	379	397	396	

- ① Cooling capacity calculated in accordance with the EN-14511-2013 standard given for outlet water temperature conditions of 7°C and 35°C outdoor temperature.
- ② Heating capacity calculated in accordance with the EN-14511-2013 standard given for outlet water temperature conditions of 45°C and 6°C WB outdoor temperature.
- ③ Total power input by compressor, motorised fan and electronic control under nominal conditions, calculated in accordance with the EN-14511-2013 standard. Options are not included.
- ④ European Seasonal Energy Efficiency Ratio (ESEER) obtained in accordance with the calculation conditions established by the certification body EUROVENT.
- ⑤ Values calculated in accordance with the EN-14825-2013 standard given for bivalente temperature of -5°C in average climate and 2°C in warmer climate.
- ⑥ Energy-efficient motors IE2.
- ⑦ Climatic warming potential of a kilogram of fluorinated greenhouse gas in relation to a kilogram of carbon dioxide over a period of 100 years.

STD VERSION: TECHNICAL CHARACTERISTICS WITH PUMP INCLUDED 30PAC/PHC

30PAC/PHC			90HEE	100HEE	120HEE	160HEE	180HEE
Cooling	Seasonal efficiency ①	ESEER	2,95	3,00	3,22	3,17	3,02
		SCOP	3,24	3,13	3,10	2,95	3,06
Heating	Seasonal efficiency ② Average climate	ηs Heat	126%	122%	121%	115%	119%
		Prated (kW)	16,83	19,20	21,83	26,21	30,53
		SCOP	3,64	3,56	3,77	3,67	3,60
	Seasonal efficiency ② Warmer climate	ηs Heat	143%	139%	148%	144%	141%
		Prated (kW)	13,12	14,69	18,05	22,40	25,83
		SCOP	3,64	3,56	3,77	3,67	3,60
Indoor circuit	Nominal water flow (m³/h)		3,2	3,7	4,5	5,4	6,2
	Pressure drop (m.w.c.)		2,3	3,1	2,5	3,5	4,6
Expansion vessel	Volume (l)		12				
	Filled pressure (kg/cm²)		1,5				
Dimensions	Length (mm)		1117	1398		2113	
	Width (mm)		860	860		860	
	Height (mm)		1447	1727		1447	
Weight	Empty (kg)		310	370	386	469	476
	In operation (kg)		327	390	408	497	503

① European Seasonal Energy Efficiency Ratio (ESEER) obtained in accordance with the calculation conditions established by the certification body EUROVENT.

② Values calculated in accordance with the EN-14825-2013 standard given for bivalent temperature of -5°C in average climate and 2°C in warmer climate.

GRAPHS OF PRESSURE DROPS IN STD VERSION

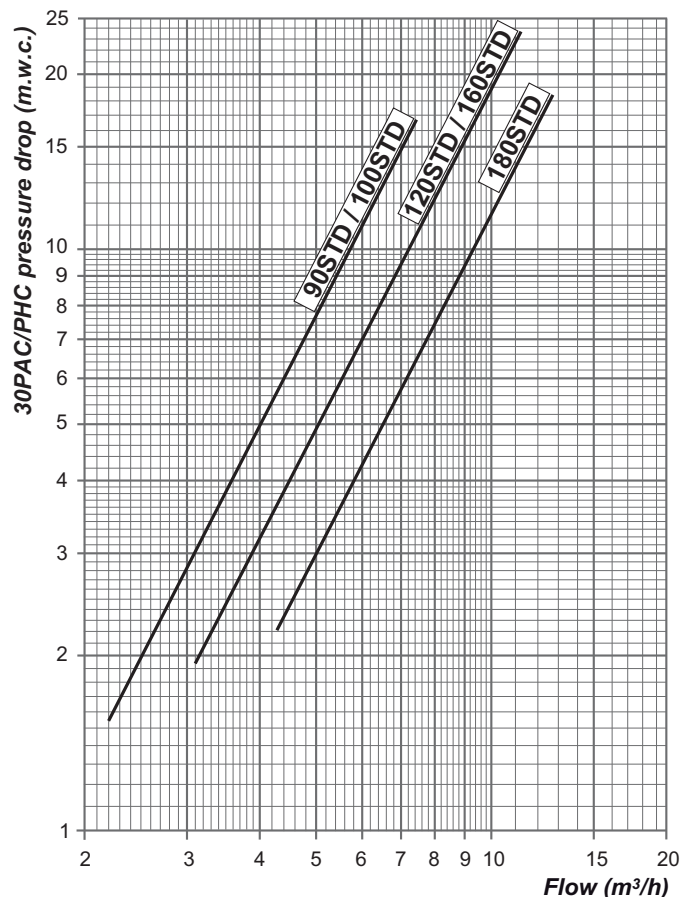
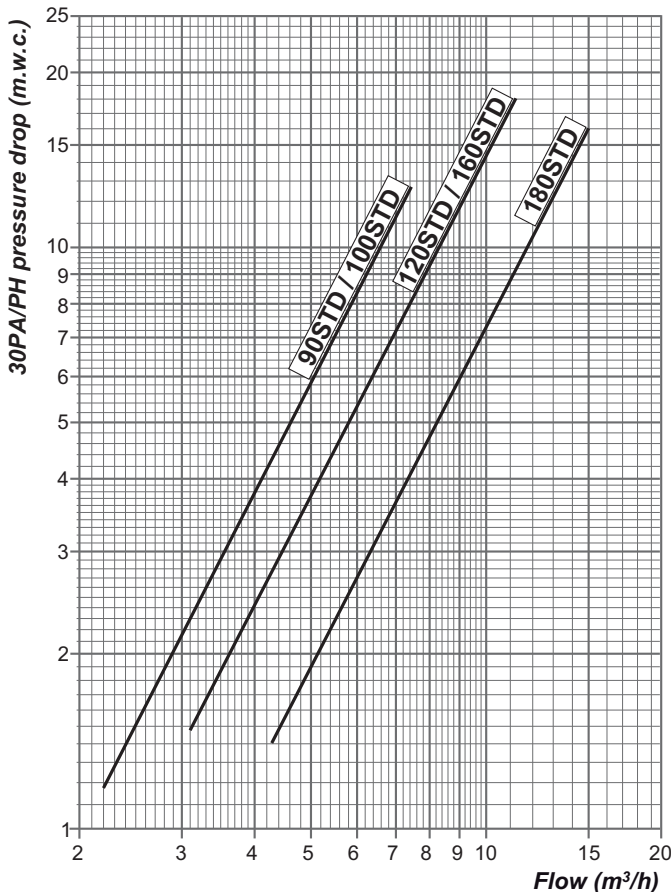

HEE VERSION: TECHNICAL CHARACTERISTICS

30PA/PH		90HEE	100HEE	120HEE	160HEE	180HEE	
Cooling capacities	Net cooling capacity ① (kW)		18,40	21,00	25,50	31,40	35,70
	Net power input ③ (kW)		7,20	7,95	9,10	11,50	13,60
	Net efficiency	EER	2,55	2,64	2,81	2,74	2,62
	Seasonal efficiency	ESEER ④	2,89	2,99	3,20	3,14	3,03
Heating capacities	Net heating capacity ② (kW)		21,40	23,90	29,30	36,40	42,50
	Net power input ③ (kW)		7,10	7,90	9,50	11,90	13,90
	Net efficiency	COP	3,03	3,03	3,08	3,05	3,05
	Seasonal efficiency ⑤ Average climate	SCOP	2,98	2,95	3,29	3,18	3,09
		ηs Heat	116%	115%	129%	124%	121%
		Prated (kW)	15,92	17,74	21,94	26,77	30,87
	Seasonal efficiency ⑤ Warmer climate	SCOP	3,41	3,58	3,82	3,67	3,65
		ηs Heat	134%	140%	150%	144%	143%
Prated (kW)		13,09	14,68	18,01	22,41	25,89	
Outdoor circuit plug-fan	Nominal air flow (m³/h)		6500	7000	10000	12200	14000
	Nominal available static pressure (mm.w.c.)		20				
	Maximum available static pressure (mm.w.c.)		63,7	70,3	45,6	65,1	62,7
	Number / diameter		1 / 500		1 / 560	2 / 560	
	Motor output (kW)		2,7	2,8	3,0	2 x 3,0	
	Power input (kW) ⑥		1,33	1,21	1,87	2,20	2,52
	Speed (r.p.m.)		1700	1780	1500	1500	
Indoor circuit	Nominal water flow (m³/h)		3,2	3,7	4,5	5,4	6,2
	Pressure drop (m.w.c.)		1,6	2,1	1,6	2,4	3,1
	Minimum water flow (m³/h)		2,5	2,9	3,4	4,1	4,6
	Maximum water flow (m³/h)		6,6	7,4	9,1	11,3	12,8
	Type of hydraulic connections		Rosca gas				
	Diameter of connections		1 1/4" M		1 1/2" M		
Compressor	Type		Scroll				
	Number of compressors / stages / circuits		1				
	Oil type		Copeland 3MAF 32 cST, Danfoss POE 160 SZ, ICI Emkarate RL 32 CF, Mobil EAL Artic 22 CC				
	Volume of oil (l)		3,0	3,3	3,3	3,3	6,2
Refrigerant	Type		R-410A				
	Global warming potential (GWP) ⑦		2.088				
	Charge (kg)		6,0	6,3	6,8	8,9	9,2
	Environment impact (tCO ₂ e)		12,5	13,2	14,2	18,6	19,2
Electrical characteristics	Electrical power supply		400 V / III ph / 50 Hz (±10%)				
	Power supply		3 Hilos + Tierra + Neutro				
Maximum absorbed current	Compressor (A)		15,2	17,3	20,5	25,4	30,5
	Fan (A)		4,2	4,3	4,6	9,2	9,2
	Control (A)		0,9	0,9	0,9	0,9	0,9
	Total (A)		20,3	22,5	26,0	35,5	40,6
Dimensions	Length (mm)		1117	1398		2113	
	Width (mm)		860	860		860	
	Height (mm)		1447	1727		1447	
Weight	Empty (kg)		294	351	368	450	455
	In operation (kg)		298	358	376	465	468

① Cooling capacity calculated in accordance with the EN-14511-2013 standard given for outlet water temperature conditions of 7°C and 35°C outdoor temperature.

② Heating capacity calculated in accordance with the EN-14511-2013 standard given for outlet water temperature conditions of 45°C and 6°C WB outdoor temperature.

③ Total power input by compressor, motorised fan and electronic control under nominal conditions, calculated in accordance with the EN-14511-2013 standard. Options are not included.

④ European Seasonal Energy Efficiency Ratio (ESEER) obtained in accordance with the calculation conditions established by the certification body EUROVENT.

⑤ Values calculated in accordance with the EN-14825-2013 standard given for bivalente temperature of -5°C in average climate and 2°C in warmer climate.

⑥ Motors that are more energy efficient than what is established by the ErP 2015 standard.

⑦ Climatic warming potential of a kilogram of fluorinated greenhouse gas in relation to a kilogram of carbon dioxide over a period of 100 years.

HEE VERSION: TECHNICAL CHARACTERISTICS WITH PUMP INCLUDED 30PAC/PHC

30PAC/PHC			90HEE	100HEE	120HEE	160HEE	180HEE
Cooling	Seasonal efficiency ①	ESEER	2,95	3,00	3,22	3,17	3,02
		SCOP	3,12	2,95	3,33	3,20	3,08
Heating	Seasonal efficiency ② Average climate	ηs Heat	122%	115%	130%	125%	120%
		Prated (kW)	15,75	17,51	21,70	26,39	30,36
		SCOP	3,64	3,56	3,77	3,67	3,60
	Seasonal efficiency ② Warmer climate	ηs Heat	143%	139%	148%	144%	141%
		Prated (kW)	13,12	14,69	18,05	22,40	25,83
		SCOP	3,64	3,56	3,77	3,67	3,60
Indoor circuit	Nominal water flow (m³/h)		3,2	3,7	4,5	5,4	6,2
	Pressure drop (m.w.c.)		2,3	3,1	2,5	3,5	4,6
Expansion vessel	Volume (l)		12				
	Filled pressure (kg/cm²)		1,5				
Dimensions	Length (mm)		1117	1398		2113	
	Width (mm)		860	860		860	
	Height (mm)		1447	1727		1447	
Weight	Empty (kg)		310	370	386	469	476
	In operation (kg)		327	390	408	497	503

① European Seasonal Energy Efficiency Ratio (ESEER) obtained in accordance with the calculation conditions established by the certification body EUROVENT.

② Values calculated in accordance with the EN-14825-2013 standard given for bivalent temperature of -5°C in average climate and 2°C in warmer climate.

GRAPHS OF PRESSURE DROPS IN HEE VERSION

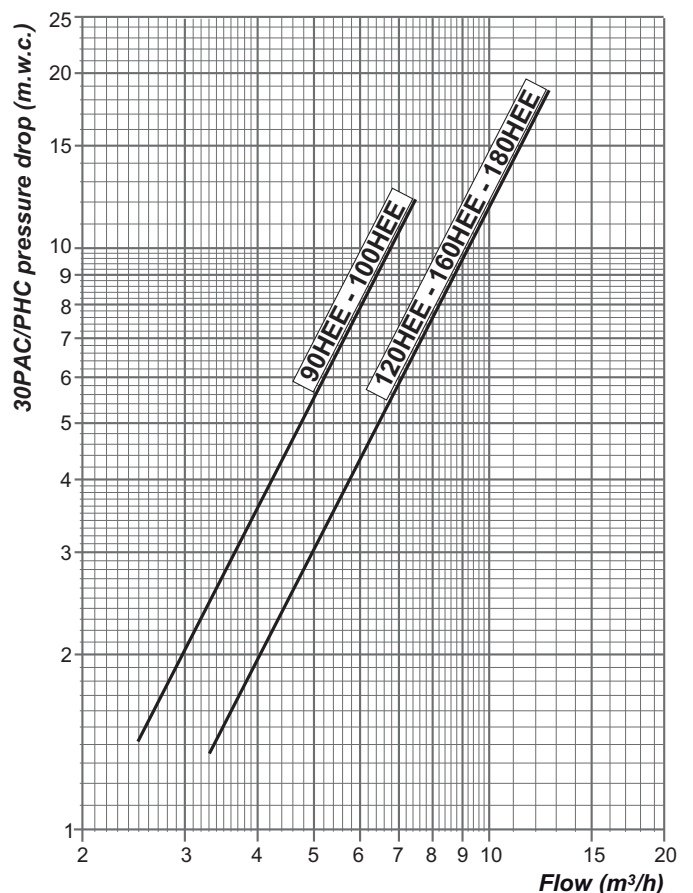
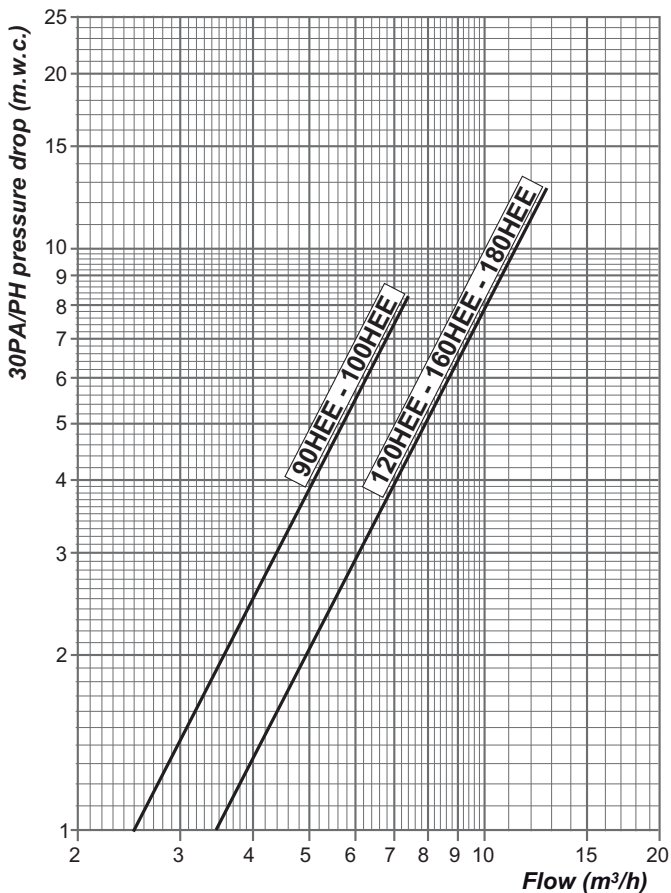

Ductable air-cooled scroll chillers and heat pumps

SCHEMATIC DIAGRAM OF THE HYDRAULIC CIRCUIT

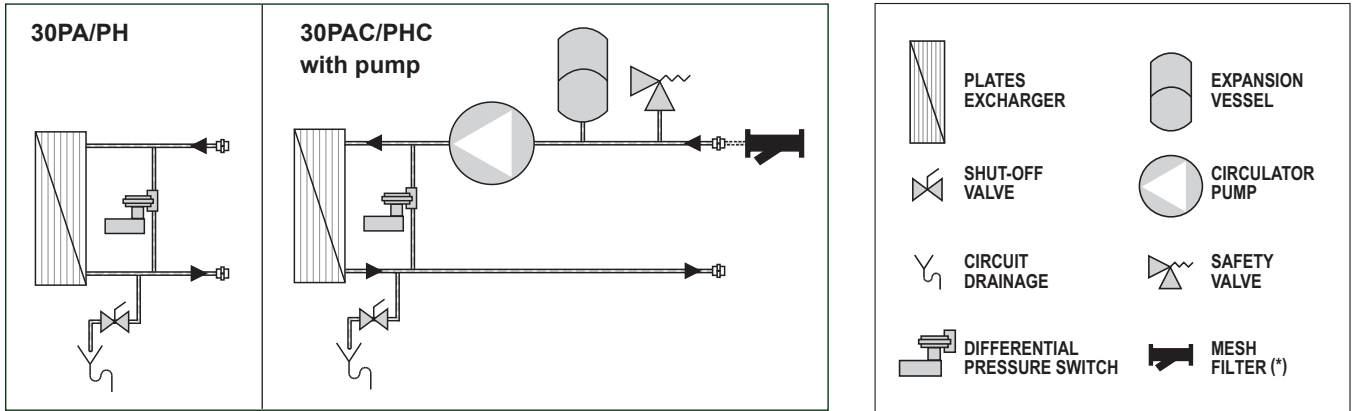

(*) Mesh filter, supplied in kit for installation by the client in 30PAC/PHC (optional for 30PA/PH).
 Cut-off and water regulation valves, as well as flexible hydraulic connections, can also be supplied in the kit.

CIRCULATION PUMPS AVAILABLE FOR 30PAC/PHC

30PAC/PHC		90STD	90HEE	100STD	100HEE	120STD	120HEE	160STD	160HEE	180STD	180HEE
Number of pump	Standard	3.171	3.171	3.172	3.172	3.172	3.172	3.173	3.173	3.174	3.174
	High-pressure (optional)	3.173	3.173	3.173	3.173	3.174	3.174	3.174	3.174	3.175	3.175
	Low-pressure (optional)	--	--	3.171	3.171	3.171	3.171	3.171	--	3.229	3.229

Note: These pumps can operate with glycol water (mono-ethylene glycol), although with a reduction of the available pressure (due to the flow variation with glycol water). Consult the correction coefficients in the chapter "Operation with glycol water".

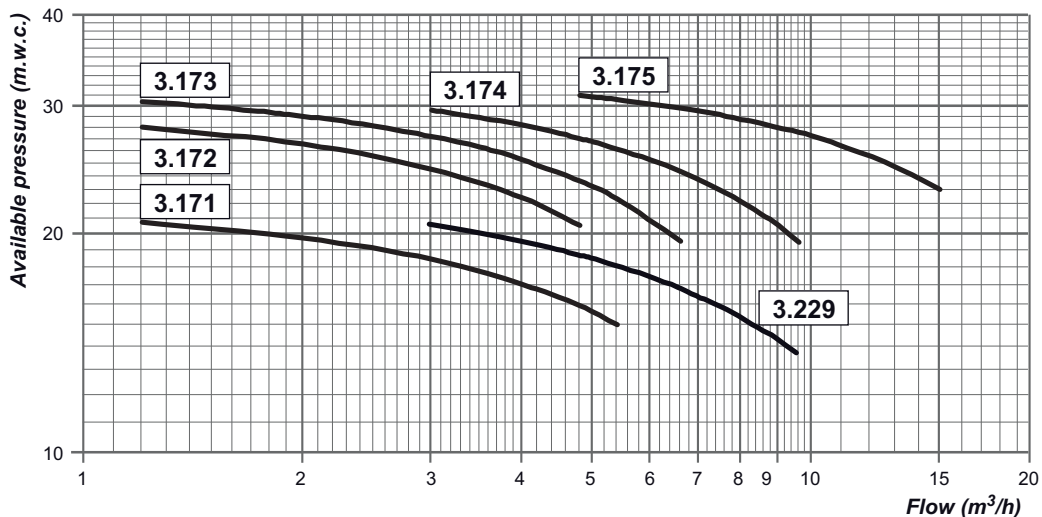

Number of pump	3.171	3.172	3.173	3.174	3.175	3.229
Motor output (kW)	0,37	0,55	0,75	0,9	1,5	0,55
Maximum absorbed current (A)	1,4	2,0	2,3	2,7	4,0	2,0
Minimum water flow (m³/h)	1,2	1,2	1,2	3,0	4,8	3,0
Maximum pressure (m.w.c.)	20,7	28,0	30,3	29,5	31,6	20,6
Maximum water flow (m³/h)	5,4	4,8	6,6	9,6	15,0	9,6
Minimum pressure (m.w.c.)	15,0	20,5	19,5	19,5	23,0	13,7

PRESSURE DROPS IN THE MESH FILTER (SENT IN THE KIT)

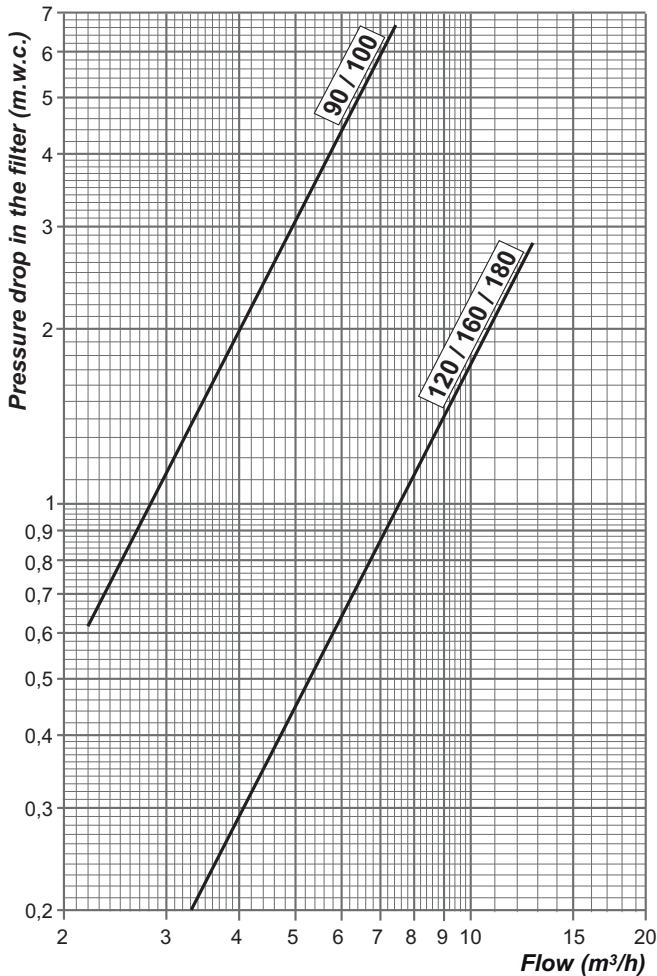

It is also necessary to install a filter in the hydraulic power supply to the unit in order to prevent clogging of the plate exchanger. Non-compliance with this recommendation can cause reduced flow which can lead to freezing and breaking of the exchanger.

For 30PAC/PHC units, a kit with a stainless steel mesh filter (500 microns) is also supplied for installation by the client.

Optionally, this kit can be supplied for 30PA/PH units.

MINIMUM VOLUME OF WATER ADMISSIBLE IN THE INSTALLATION (COOLING MODE)

The electronic control for the 30PA/PH units incorporates an auto-adaptive control for the compressor operating time based on the time set for anti-short-cycle.

This control reduces the number of times the compressor is started up and permanently adjusts the system's thermal inertia, favouring the reduction of the minimum volume of water in the installation.

The size of the buffer tank can also be decreased since the unit will be stopped for less time.

30PAC/PHC	STD version					HEE version				
	90STD	100STD	120STD	160STD	180STD	90HEE	100HEE	120HEE	160HEE	180HEE
Minimum volume (litres)	101	120	143	187	204	107	132	152	189	210

The calculation of the minimum water volume has been done for nominal EUROVENT conditions, only in cooling mode. This value is applicable for the majority of refrigeration applications (group with fan-coil units).

Note: the buffer tank is indispensable in installations that operate with a reduced volume of water (group with an air handling unit) or for industrial processes.

For applications with a heat pump, it is recommended that the buffer tank be used in order to maintain a stable temperature during the defrosting cycles.



Ductable air-cooled scroll chillers and heat pumps

COOLING CAPACITY OF THE STD VERSION (kW)

COOLING-ONLY and REVERSIBLE units

30PA 30PH 30PAC 30PHC	Temperature of outlet cold water from the evaporator in °C	Inlet temperature of outdoor air into the condenser in °C														
		20		25		30		35		40		44		46		
		Pf	Pa	Pf	Pa	Pf	Pa	Pf	Pa	Pf	Pa	Pf	Pa	Pf	Pa	
90STD	Glycol water	-7	13,6	4,5	12,9	5,0	12,0	5,5	11,1	6,0	10,3	6,6	9,5	7,1	9,1	7,4
		-4	15,0	4,6	14,2	5,1	13,3	5,6	12,3	6,1	11,3	6,7	10,5	7,2	10,1	7,5
		0	17,2	4,8	16,2	5,3	15,2	5,8	14,2	6,4	13,0	7,0	12,1	7,5	11,7	7,7
		2	18,3	4,9	17,3	5,4	16,2	5,9	15,0	6,5	13,9	7,1	13,0	7,6	12,5	7,9
	Pure water	5	20,3	5,1	19,1	5,6	17,9	6,1	16,5	6,7	15,2	7,3	14,2	7,8	13,7	8,0
		7	21,8	5,3	20,5	5,7	19,2	6,3	17,8	6,8	16,4	7,5	15,2	7,9	14,8	8,2
		10	23,7	5,4	22,3	5,9	20,9	6,5	19,4	7,0	17,9	7,7	16,7	8,2	16,1	8,4
		12	24,9	5,6	23,5	6,1	22,1	6,6	20,4	7,2	18,9	7,8	17,6	8,3	17,0	8,5
		15	26,9	5,8	25,4	6,3	23,8	6,8	22,1	7,4	20,4	8,0	19,0	8,5	18,4	8,7
18	29,0	5,9	27,3	6,5	25,6	7,0	23,8	7,6	22,0	8,2	20,6	8,7	19,8	8,9		
100STD	Glycol water	-7	15,5	5,2	14,9	5,8	14,1	6,3	13,4	7,0	12,5	7,7	11,7	8,3	11,3	8,6
		-4	17,3	5,3	16,5	5,9	15,6	6,5	14,8	7,1	13,8	7,8	13,0	8,4	12,5	8,7
		0	20,0	5,6	19,0	6,1	18,0	6,7	16,9	7,4	15,8	8,1	14,8	8,7	14,3	9,0
		2	21,4	5,7	20,3	6,3	19,2	6,9	18,0	7,5	16,8	8,2	15,8	8,8	15,2	9,1
	Pure water	5	23,8	6,0	22,6	6,5	21,4	7,1	20,0	7,7	18,5	8,4	17,4	9,0	16,8	9,3
		7	25,5	6,1	24,2	6,7	22,8	7,3	21,3	7,9	19,7	8,6	18,5	9,2	17,8	9,5
		10	27,9	6,4	26,3	6,9	24,8	7,5	23,1	8,2	21,4	8,8	20,0	9,4	19,3	9,7
		12	29,4	6,5	27,8	7,1	26,1	7,7	24,3	8,3	22,5	9,0	21,1	9,6	20,3	9,9
		15	31,8	6,8	30,0	7,3	28,2	7,9	26,3	8,6	24,4	9,2	22,8	9,8	22,0	10,1
18	34,4	7,1	32,4	7,6	30,3	8,2	28,4	8,8	26,3	9,5	24,5	10,0	23,6	10,3		
120STD	Glycol water	-7	19,1	5,7	18,1	6,3	16,9	6,9	15,7	7,6	14,4	8,4	13,4	9,0	12,9	9,3
		-4	21,1	5,8	20,0	6,4	18,8	7,0	17,3	7,7	15,8	8,5	14,7	9,1	14,2	9,4
		0	23,9	6,0	22,6	6,6	21,3	7,3	19,9	8,0	18,4	8,7	17,2	9,4	16,6	9,7
		2	25,3	6,1	24,1	6,8	22,7	7,4	21,3	8,1	19,8	8,9	18,5	9,6	17,9	9,9
	Pure water	5	28,3	6,4	26,8	7,0	25,3	7,7	23,7	8,4	22,0	9,2	20,6	9,8	19,9	10,2
		7	30,3	6,5	28,7	7,2	27,0	7,8	25,3	8,6	23,5	9,3	22,0	10,0	21,3	10,3
		10	33,0	6,8	31,2	7,4	29,4	8,1	27,5	8,8	25,6	9,5	24,0	10,2	23,2	10,6
		12	34,8	6,9	33,0	7,5	31,1	8,2	29,1	9,0	27,1	9,7	25,4	10,4	24,5	10,7
		15	37,8	7,1	35,7	7,8	33,7	8,5	31,5	9,2	29,5	10,0	27,5	10,6	26,6	11,0
18	40,8	7,4	38,6	8,0	36,3	8,7	34,3	9,4	32,1	10,2	30,1	10,9	29,2	11,2		
160STD	Glycol water	-7	22,6	7,0	21,2	7,7	19,9	8,6	18,5	9,5	17,2	10,6	16,1	11,5	15,5	12,0
		-4	27,1	7,3	25,5	8,1	24,1	8,9	22,6	9,9	21,1	10,9	19,7	11,8	19,1	12,3
		0	30,7	7,5	29,3	8,3	27,7	9,2	26,0	10,1	24,2	11,2	22,7	12,1	21,9	12,6
		2	32,7	7,7	31,1	8,5	29,5	9,3	27,7	10,3	25,8	11,3	24,3	12,3	23,3	12,7
	Pure water	5	36,5	7,9	34,7	8,7	32,8	9,6	30,8	10,6	28,6	11,6	26,8	12,5	25,9	13,0
		7	39,1	8,1	37,2	8,9	35,1	9,8	33,0	10,8	30,6	11,8	28,8	12,7	27,9	13,1
		10	42,5	8,4	40,4	9,2	38,2	10,1	35,8	11,0	33,3	12,1	31,2	12,9	30,2	13,4
		12	45,0	8,5	42,7	9,3	40,3	10,2	37,8	11,2	35,2	12,2	33,2	13,1	32,1	13,5
		15	48,6	8,8	46,2	9,6	43,6	10,5	40,7	11,4	38,1	12,5	35,9	13,4	34,8	13,8
18	52,5	9,1	49,9	9,9	47,0	10,8	44,1	11,8	41,2	12,8	38,9	13,7	37,6	14,1		
180STD	Glycol water	-7	27,0	8,6	25,5	9,4	23,9	10,4	22,2	11,5	20,4	12,7	18,9	13,7	18,2	14,2
		-4	29,9	8,7	28,3	9,6	26,5	10,6	24,6	11,7	22,5	12,8	20,9	13,8	20,0	14,3
		0	34,3	9,0	32,5	9,9	30,5	10,9	28,5	12,0	26,3	13,2	24,5	14,2	23,8	14,7
		2	36,6	9,1	34,6	10,0	32,5	11,1	30,3	12,1	28,1	13,3	26,2	14,4	25,3	14,9
	Pure water	5	40,8	9,4	38,6	10,3	36,2	11,3	33,8	12,4	31,3	13,6	29,4	14,7	28,2	15,2
		7	43,6	9,6	41,2	10,5	38,8	11,6	36,2	12,7	33,5	13,8	31,3	14,9	30,2	15,4
		10	47,6	9,9	45,0	10,8	42,3	11,9	39,3	12,9	36,6	14,1	34,2	15,2	33,0	15,7
		12	50,3	10,1	47,6	11,0	44,6	12,0	41,6	13,1	38,6	14,3	36,1	15,3	34,9	15,9
		15	54,5	10,4	51,5	11,2	48,4	12,3	45,2	13,5	41,7	14,6	39,0	15,6	37,6	16,1
18	58,8	10,7	55,6	11,6	52,2	12,7	48,8	13,8	45,3	15,0	42,4	16,0	40,9	16,5		

Pf: Gross cooling capacity in kW
Pa: Compressor power input in kW

Zone where use of glycol water is mandatory

Can be interpolated among the values of the table, never extrapolated



Ductable air-cooled scroll chillers and heat pumps

HEATING CAPACITY OF THE STD VERSION (kW)

REVERSIBLE units

30PH 30PHC	Inlet temperature of outdoor air into the evaporator in °C DB ①	Temperature of outlet hot water from the condenser in °C											
		30		35		40		45		50		55	
		Pc	Pa	Pc	Pa	Pc	Pa	Pc	Pa	Pc	Pa	Pc	Pa
90STD	-15	12,5	4,4	12,5	4,9	12,3	5,4	12,2	6,1	--	--	--	--
	-12	13,6	4,4	13,6	4,9	13,4	5,5	13,1	6,1	--	--	--	--
	-10	14,4	4,5	14,3	5,0	14,1	5,5	13,8	6,1	--	--	--	--
	-5	16,8	4,5	16,6	5,0	16,3	5,6	16,0	6,2	15,7	6,9	--	--
	0	19,3	4,6	19,0	5,1	18,7	5,6	18,2	6,2	17,8	7,0	17,2	7,8
	5	21,7	4,7	21,4	5,2	21,0	5,7	20,7	6,3	20,2	7,0	19,5	7,8
	7	22,7	4,7	22,4	5,2	22,0	5,7	21,6	6,3	21,1	7,0	20,5	7,8
	10	24,4	4,7	23,9	5,2	23,5	5,8	23,0	6,4	22,5	7,1	21,7	7,9
	15	27,4	4,8	26,7	5,3	26,1	5,8	25,5	6,4	25,0	7,1	24,3	7,9
20	29,9	4,9	29,3	5,4	28,6	5,9	27,9	6,5	27,1	7,2	26,3	8,0	
100STD	-15	14,6	5,3	14,6	5,8	14,4	6,4	14,4	7,2	--	--	--	--
	-12	15,9	5,3	16,0	5,8	15,9	6,5	15,7	7,2	--	--	--	--
	-10	17,1	5,3	16,9	5,9	16,8	6,5	16,6	7,3	--	--	--	--
	-5	19,8	5,4	19,6	6,0	19,5	6,6	19,2	7,3	19,0	8,1	--	--
	0	22,7	5,5	22,5	6,1	22,3	6,7	21,9	7,4	21,3	8,2	20,8	9,1
	5	25,8	5,6	25,4	6,2	25,1	6,8	24,6	7,5	24,0	8,3	23,4	9,2
	7	27,2	5,6	26,8	6,2	26,4	6,8	25,9	7,6	25,4	8,3	24,7	9,2
	10	29,1	5,7	28,6	6,3	28,1	6,9	27,5	7,6	26,9	8,4	26,3	9,3
	15	32,4	5,8	31,8	6,4	31,2	7,0	30,5	7,7	29,8	8,5	29,0	9,4
20	35,7	6,0	35,0	6,5	34,2	7,1	33,3	7,8	32,4	8,6	31,5	9,5	
120STD	-15	17,4	5,8	17,2	6,4	17,0	7,1	16,8	8,0	--	--	--	--
	-12	18,9	5,8	18,7	6,4	18,5	7,2	18,2	8,0	--	--	--	--
	-10	20,0	5,9	19,8	6,5	19,6	7,2	19,3	8,0	--	--	--	--
	-5	23,0	6,0	22,7	6,6	22,3	7,3	22,0	8,1	21,7	9,0	--	--
	0	26,3	6,0	25,9	6,7	25,5	7,4	25,1	8,2	24,7	9,1	24,2	10,1
	5	29,7	6,1	29,2	6,8	28,6	7,5	28,1	8,3	27,5	9,2	26,9	10,2
	7	31,1	6,2	30,5	6,8	30,0	7,6	29,5	8,4	28,9	9,2	28,3	10,2
	10	33,5	6,2	32,7	6,9	32,1	7,6	31,4	8,5	30,7	9,3	30,0	10,3
	15	37,3	6,4	36,4	7,0	35,6	7,7	34,8	8,6	34,0	9,4	33,1	10,4
20	41,0	6,4	40,0	7,1	39,0	7,8	37,9	8,7	37,0	9,5	35,9	10,4	
160STD	-15	21,9	7,6	21,7	8,5	21,5	9,5	21,2	10,8	--	--	--	--
	-12	24,1	7,7	23,9	8,5	23,7	9,6	23,5	10,8	--	--	--	--
	-10	25,4	7,7	25,2	8,6	25,0	9,6	24,8	10,8	--	--	--	--
	-5	29,5	7,8	29,0	8,6	28,6	9,7	28,3	10,9	27,7	12,1	--	--
	0	33,6	7,9	33,1	8,7	32,5	9,7	32,2	10,9	31,7	12,2	31,2	13,7
	5	38,2	8,0	37,5	8,8	36,7	9,8	35,8	11,0	35,2	12,2	34,8	13,7
	7	40,1	8,0	39,4	8,9	38,8	9,9	38,0	11,0	37,3	12,2	36,6	13,7
	10	43,1	8,1	42,3	8,9	41,5	9,9	40,6	11,0	39,7	12,3	38,7	13,7
	15	48,2	8,2	47,2	9,1	46,1	10,0	45,1	11,1	43,9	12,3	42,7	13,8
20	53,1	8,3	51,9	9,2	50,7	10,1	49,4	11,2	47,9	12,4	46,6	13,9	
180STD	-15	25,1	8,9	24,9	9,9	24,9	11,1	24,8	12,2	--	--	--	--
	-12	27,3	8,9	27,0	9,9	26,9	11,1	26,8	12,2	--	--	--	--
	-10	29,0	8,9	28,6	9,9	28,4	11,1	28,2	12,2	--	--	--	--
	-5	33,2	8,9	32,6	10,0	32,2	11,2	31,8	12,2	31,5	13,6	--	--
	0	37,9	8,9	37,3	10,0	36,7	11,2	36,0	12,3	35,4	13,7	34,7	15,2
	5	42,8	9,0	42,0	10,0	41,1	11,2	40,4	12,3	39,5	13,7	38,7	15,3
	7	44,8	9,0	43,9	10,1	43,1	11,3	42,4	12,3	41,3	13,7	40,2	15,3
	10	47,9	9,0	47,1	10,1	46,1	11,3	45,1	12,4	44,1	13,8	43,0	15,3
	15	53,5	9,1	52,4	10,1	51,2	11,3	50,1	12,4	48,7	13,8	47,3	15,4
20	58,7	9,1	57,4	10,2	56,0	11,4	54,8	12,5	53,0	13,9	51,5	15,4	

Pc: Gross heating capacity in kW

Pa: Compressor power input in kW

Can be interpolated among the values of the table, never extrapolated

① Variation of the relative humidity for the calculations: -20°C 95%RH / +7°C 85%RH / +27°C 50%RH



Ductable air-cooled scroll chillers and heat pumps

COOLING CAPACITY OF THE HEE VERSION (kW)

COOLING-ONLY and REVERSIBLE units

30PA 30PH 30PAC 30PHC	Temperature of outlet cold water from the evaporator in °C	Inlet temperature of outdoor air into the condenser in °C														
		20		25		30		35		40		44		46		
		Pf	Pa	Pf	Pa	Pf	Pa	Pf	Pa	Pf	Pa	Pf	Pa	Pf	Pa	
90HEE	Glycol water	-7	13,9	4,1	13,2	4,5	12,4	5,0	11,4	5,6	10,4	6,2	9,6	6,8	--	--
		-4	15,3	4,2	14,5	4,6	13,7	5,1	12,7	5,7	11,5	6,3	10,7	6,9	10,2	7,2
		0	17,5	4,3	16,6	4,8	15,6	5,3	14,6	5,8	13,5	6,5	12,2	7,0	11,7	7,3
		2	18,7	4,4	17,7	4,9	16,7	5,4	15,5	5,9	14,2	6,7	13,4	7,1	12,5	7,4
	Pure water	5	20,8	4,6	19,7	5,0	18,5	5,5	17,3	6,1	16,0	6,7	14,8	7,2	13,9	7,5
		7	22,2	4,7	21,0	5,1	19,8	5,6	18,5	6,2	17,0	6,8	15,9	7,4	14,8	7,6
		10	24,2	4,8	22,9	5,3	21,5	5,8	20,1	6,4	18,6	7,0	17,3	7,5	16,7	7,8
		12	25,5	4,9	24,2	5,4	22,7	5,9	21,2	6,5	19,6	7,1	18,3	7,6	17,7	7,9
		15	27,6	5,1	26,1	5,6	24,6	6,1	23,0	6,7	21,3	7,3	19,9	7,8	19,2	8,1
18	29,8	5,3	28,2	5,8	26,5	6,3	24,7	6,9	23,0	7,5	21,5	8,0	20,8	8,3		
100HEE	Glycol water	-7	15,7	4,6	14,9	5,2	13,9	5,7	13,0	6,4	12,0	7,1	11,1	7,8	--	--
		-4	17,4	4,7	16,5	5,3	15,5	5,8	14,4	6,5	13,3	7,2	12,4	7,9	11,9	8,2
		0	19,9	4,9	18,9	5,4	17,8	6,0	16,7	6,7	15,4	7,4	14,4	8,0	13,9	8,4
		2	21,2	5,0	20,2	5,5	19,0	6,1	17,7	6,8	16,5	7,5	15,4	8,1	14,8	8,4
	Pure water	5	23,6	5,2	22,4	5,7	21,1	6,3	19,7	6,9	18,3	7,7	17,2	8,3	16,6	8,6
		7	25,2	5,3	23,9	5,8	22,4	6,4	21,1	7,1	19,6	7,8	18,4	8,4	17,8	8,7
		10	27,4	5,5	26,0	6,0	24,4	6,6	22,9	7,3	21,3	8,0	20,0	8,6	19,4	8,9
		12	28,9	5,6	27,4	6,2	25,8	6,8	24,1	7,4	22,5	8,1	21,1	8,7	20,5	9,0
		15	31,2	5,9	29,5	6,4	27,8	7,0	26,1	7,7	24,4	8,3	22,9	9,0	22,2	9,3
18	33,6	6,2	31,8	6,7	29,9	7,3	28,1	7,9	26,2	8,6	24,7	9,2	24,0	9,5		
120HEE	Glycol water	-7	19,2	5,1	18,1	5,7	16,9	6,4	15,7	7,1	14,4	8,0	13,2	8,7	--	--
		-4	21,2	5,2	20,0	5,8	18,7	6,5	17,4	7,2	16,0	8,1	14,8	8,8	14,2	9,2
		0	24,3	5,3	22,9	5,9	21,6	6,7	20,1	7,4	18,5	8,3	17,2	9,0	16,6	9,4
		2	25,8	5,4	24,4	6,1	23,0	6,7	21,5	7,5	19,8	8,3	18,4	9,1	17,7	9,5
	Pure water	5	28,7	5,6	27,2	6,2	25,6	6,9	23,9	7,7	22,1	8,5	20,6	9,2	19,8	9,6
		7	30,7	5,7	29,1	6,3	27,4	7,0	25,6	7,8	23,7	8,6	22,1	9,3	21,3	9,7
		10	33,3	5,9	31,7	6,5	29,8	7,2	27,9	7,9	25,8	8,8	24,0	9,5	23,3	9,9
		12	35,2	6,0	33,5	6,6	31,6	7,3	29,5	8,1	27,4	8,9	25,6	9,6	24,7	10,0
		15	38,2	6,2	36,3	6,8	34,2	7,5	32,1	8,3	29,7	9,1	27,9	9,8	27,0	10,2
18	41,2	6,5	39,2	7,1	37,0	7,7	34,7	8,5	32,3	9,3	30,3	10,0	29,2	10,4		
160HEE	Glycol water	-7	23,6	6,6	22,4	7,2	21,1	8,2	18,5	8,9	17,1	9,8	15,9	10,7	--	--
		-4	26,1	6,7	24,7	7,5	23,3	8,3	20,5	9,0	18,9	10,0	17,6	10,8	17,0	11,2
		0	29,9	7,0	27,5	7,6	26,8	8,5	23,5	9,4	23,0	10,4	20,3	11,1	19,5	11,5
		2	31,8	7,1	30,1	7,9	28,5	8,7	26,6	9,6	24,5	10,4	22,5	11,3	20,8	11,7
	Pure water	5	35,4	7,4	33,6	8,1	31,7	8,9	29,6	9,8	27,4	10,8	25,5	11,6	23,4	12,1
		7	37,9	7,6	35,8	8,3	33,8	9,1	31,6	10,0	29,3	11,0	27,4	11,9	26,2	12,3
		10	41,1	7,8	39,0	8,6	36,8	9,4	34,4	10,3	31,7	11,3	29,8	12,1	28,7	12,5
		12	43,5	8,0	41,3	8,7	38,8	9,6	37,3	10,5	33,7	11,5	31,4	12,3	30,3	12,7
		15	47,3	8,3	44,7	9,0	42,1	9,8	39,3	10,7	36,5	11,7	34,1	12,6	32,9	13,0
18	51,2	8,5	48,4	9,3	45,5	10,1	42,4	11,1	39,3	12,0	36,8	12,9	35,6	13,3		
180HEE	Glycol water	-7	25,4	7,8	24,2	8,6	23,9	9,6	20,7	10,5	19,1	11,6	17,8	12,6	--	--
		-4	29,6	8,1	28,1	8,9	27,3	9,7	22,8	10,7	21,1	11,8	19,7	12,8	18,9	13,3
		0	33,9	8,4	32,1	9,3	30,3	10,2	28,4	11,2	24,4	12,1	22,6	13,1	21,8	13,6
		2	36,0	8,6	34,2	9,4	32,3	10,4	30,2	11,4	27,1	12,4	24,4	13,3	23,2	13,8
	Pure water	5	40,1	8,9	38,0	9,7	35,8	10,7	33,6	11,7	31,2	12,8	28,0	13,5	26,4	14,2
		7	42,9	9,1	40,6	9,9	38,3	10,9	35,8	11,9	33,3	13,1	31,1	14,0	29,5	14,5
		10	46,5	9,3	44,2	10,2	41,6	11,2	39,0	12,2	36,1	13,4	33,8	14,3	32,6	14,8
		12	49,4	9,6	46,7	10,4	44,0	11,4	41,2	12,4	38,2	13,6	35,8	14,5	34,5	15,0
		15	53,5	9,8	50,6	10,8	47,6	11,7	44,6	12,8	41,4	13,9	38,8	14,8	37,5	15,3
18	57,9	10,2	54,7	11,1	51,5	12,0	48,1	13,1	44,7	14,2	41,9	15,2	40,5	15,6		

Pf: Gross cooling capacity in kW
Pa: Compressor power input in kW

Zone where use of glycol water is mandatory

Can be interpolated among the values of the table, never extrapolated



Ductable air-cooled scroll chillers and heat pumps

HEATING CAPACITY OF THE HEE VERSION (kW)

REVERSIBLE units

30PH 30PHC	Inlet temperature of outdoor air into the evaporator in °C DB ①	Temperature of outlet hot water from the condenser in °C											
		30		35		40		45		50		55	
		Pc	Pa	Pc	Pa	Pc	Pa	Pc	Pa	Pc	Pa	Pc	Pa
90HEE	-15	12,5	4,2	--	--	--	--	--	--	--	--	--	--
	-12	13,5	4,3	13,4	4,7	0,0	--	--	--	--	--	--	--
	-10	14,3	4,3	14,1	4,7	14,0	5,3	--	--	--	--	--	--
	-5	16,6	4,3	16,4	4,8	15,9	5,4	15,7	6,0	--	--	--	--
	0	19,0	4,3	18,7	4,8	18,4	5,4	18,0	6,0	--	--	--	--
	5	21,5	4,4	21,1	4,8	20,7	5,4	20,3	6,0	19,8	6,8	--	--
	7	22,6	4,4	22,1	4,9	21,7	5,4	21,3	6,0	20,8	6,8	20,0	7,7
	10	24,1	4,4	23,6	4,9	23,1	5,4	22,6	6,1	22,1	6,8	21,1	7,7
	15	26,4	4,5	25,7	5,0	25,2	5,5	24,6	6,1	23,9	6,8	23,3	7,7
20	28,0	4,5	27,4	5,0	26,8	5,5	26,2	6,1	25,6	6,8	25,1	7,7	
100HEE	-15	13,7	4,8	13,4	5,4	--	--	--	--	--	--	--	--
	-12	15,2	4,9	14,7	5,5	14,5	6,2	--	--	--	--	--	--
	-10	16,1	4,9	15,6	5,5	15,4	6,2	--	--	--	--	--	--
	-5	18,4	4,9	18,2	5,5	17,5	6,2	17,3	6,9	--	--	--	--
	0	21,1	4,9	20,8	5,5	20,5	6,2	19,7	6,9	19,3	7,8	--	--
	5	23,9	5,0	23,5	5,5	23,1	6,2	22,6	6,9	22,1	7,8	21,3	8,8
	7	25,1	5,0	24,6	5,5	24,2	6,2	23,8	7,0	23,2	7,8	22,2	8,8
	10	26,7	5,0	26,2	5,5	25,7	6,2	25,2	7,0	24,7	7,8	23,5	8,8
	15	29,2	5,0	28,7	5,6	28,0	6,2	27,4	7,0	26,8	7,8	26,1	8,9
20	31,1	5,0	30,4	5,6	29,8	6,3	29,2	7,0	28,5	7,8	27,9	8,9	
120HEE	-15	17,1	5,5	16,8	6,2	16,5	7,0	--	--	--	--	--	--
	-12	18,7	5,6	18,3	6,3	18,0	7,1	--	--	--	--	--	--
	-10	19,8	5,6	19,4	6,3	19,0	7,2	--	--	--	--	--	--
	-5	22,8	5,7	22,3	6,4	21,8	7,2	21,4	8,1	--	--	--	--
	0	26,1	5,7	25,6	6,4	25,0	7,2	24,5	8,1	23,8	9,2	--	--
	5	29,7	5,7	29,0	6,4	28,4	7,3	27,7	8,1	27,0	9,2	26,2	10,3
	7	31,1	5,7	30,4	6,5	29,7	7,3	29,1	8,2	28,3	9,2	27,4	10,4
	10	33,2	5,7	32,5	6,5	31,7	7,3	30,9	8,2	30,0	9,2	29,1	10,4
	15	36,2	5,8	35,4	6,5	34,6	7,3	33,7	8,2	32,7	9,2	31,7	10,4
20	38,6	5,8	37,9	6,5	37,0	7,3	36,2	8,2	35,4	9,2	34,5	10,4	
160HEE	-15	20,4	7,0	20,1	7,9	--	--	--	--	--	--	--	--
	-12	23,1	7,1	21,9	7,9	21,6	8,9	--	--	--	--	--	--
	-10	24,5	7,2	23,3	8,0	22,9	8,9	--	--	--	--	--	--
	-5	28,2	7,2	26,8	8,2	26,2	9,1	25,7	10,2	--	--	--	--
	0	32,3	7,4	31,8	8,2	31,3	9,2	30,7	10,3	30,0	11,5	--	--
	5	36,7	7,5	36,0	8,4	35,3	9,3	34,5	10,4	33,7	11,6	31,3	12,8
	7	38,4	7,6	37,7	8,4	36,9	9,4	36,2	10,4	35,2	11,6	32,7	12,9
	10	41,0	7,7	40,2	8,5	39,3	9,4	38,3	10,5	37,3	11,6	35,4	13,0
	15	44,8	7,8	43,9	8,6	42,8	9,5	41,7	10,6	40,5	11,8	39,2	13,1
20	47,9	7,8	46,8	8,7	45,7	9,6	44,8	10,7	43,8	11,9	42,6	13,2	
180HEE	-15	24,8	8,4	23,3	9,3	--	--	--	--	--	--	--	--
	-12	27,1	8,5	25,4	9,4	23,9	10,5	--	--	--	--	--	--
	-10	28,7	8,5	27,7	9,5	26,5	10,6	--	--	--	--	--	--
	-5	33,0	8,6	32,6	9,6	30,9	10,6	29,9	11,9	--	--	--	--
	0	37,7	8,8	37,2	9,8	36,6	10,8	34,9	12,0	33,2	13,4	--	--
	5	42,8	9,0	42,0	9,9	41,2	11,0	40,5	12,1	38,9	13,5	37,2	15,1
	7	44,8	9,1	44,0	10,0	43,0	11,0	42,3	12,2	41,2	13,6	38,9	15,1
	10	47,9	9,1	46,8	10,1	45,9	11,1	44,8	12,3	43,6	13,7	42,3	15,2
	15	52,3	9,2	51,1	10,2	50,0	11,2	48,7	12,3	47,3	13,7	45,8	15,3
20	55,6	9,3	54,5	10,3	53,3	11,3	52,2	12,5	51,0	13,8	49,8	15,3	

Pc: Gross heating capacity in kW

Pa: Compressor power input in kW

Can be interpolated among the values of the table, never extrapolated

① Variation of the relative humidity for the calculations: -20°C 95%RH / +7°C 85%RH / +27°C 50%RH



Ductable air-cooled scroll chillers and heat pumps

EVAPORATOR OPERATING LIMITS

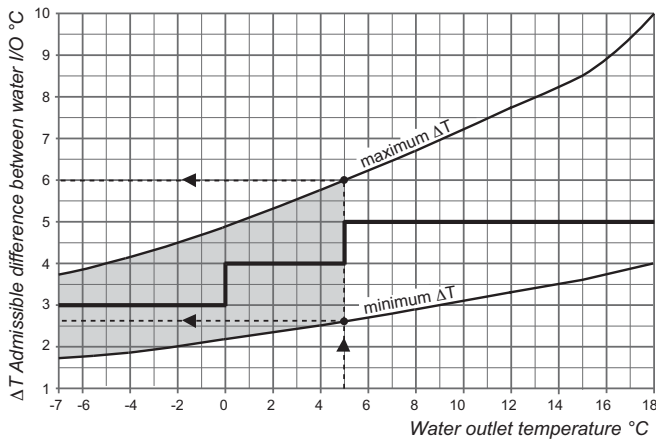

The curves represent the minimum and maximum admissible temperature increases based on the outlet temperature, for both pure water and glycol water.

The minimum outlet temperature for the unit will be +5°C with pure water and -7°C with glycol water.

For temperature changes that are not listed between the curves, please consult.

• *Example*

For an outlet water temperature of +5°C:

Minimum ΔT : 2,6°C → T. condition 7,6°C / 5°C

Maximum ΔT : 6,0°C → T. condition 11°C / 5°C

OPERATION WITH GLYCOL WATER

Correction coefficients			Positive conditions		Negative conditions	
			K	Calculation method	K	Calculation method
Evaporator	Cooling capacity	E1	0,98	$Pf_c = Pf \times 0,98$	1,0	According to the table of capacities
	Cold water flow	E2	1,05	$Q_c = [(Pf_c \times 0,86) / \Delta T] \times 1,05$	1,1	$Q_c = [(Pf_c \times 0,86) / \Delta T] \times 1,1$
	Water flow resistance	E3	1,15	$\Delta P_c = \Delta P \times 1,15$	1,3	$\Delta P_c = \Delta P \times 1,3$
	Average working conditions			12 / 7 °C		See evaporator operating limits
Condenser	Heating capacity	E1	0,97	$Pf_c = Pf \times 0,97$		--
	Hot water flow	E2	1,05	$Q_c = [(Pf_c \times 0,86) / \Delta T] \times 1,05$		--
	Water flow resistance	E3	1,10	$\Delta P_c = \Delta P \times 1,10$		--
	Average working conditions			35 / 40 °C		--

Example selection for operation with glycol water in the evaporator

Positive condition - Anti-freeze operation

DATA

- Unit: **30PHA-100TD**
- Temperature of inlet cold water: +12°C
- Temperature of outlet cold water: +7°C
- $\Delta T = +5°C$
- Outdoor air temperature: 35 °C
- Mono-ethylene glycol (MEG): 30%

DETERMINE

- Cooling capacity, glycol water flow, and pressure available.

SOLUTION

- Cooling capacity (table of capacities): $21,29 \times 860 = 18.309$ kcal/h
- Correction coefficient E1 = 0,98
- Corrected cooling capacity: $Pf_c = 18.309 \times 0,98 = 17.943$ kcal/h
- Cold water flow: $Q = 17.943 / 5 = 3.589$ l/h = 3,59 m³/h
- Correction coefficient E2 = 1,05
- Corrected flow: $Q_c = 3,59 \times 1,05 = 3,77$ m³/h
- Water flow resistance (according to the graph): $\Delta P = 3,9$ m.w.c.
- Correction coefficient E3 = 1,15
- Corrected water flow resistance: $\Delta P_c = 3,9 \times 1,15 = 4,5$ m.w.c.
- Pump's available pressure: 23,0 m.w.c.
- Unit's available pressure: $23,0 - 4,5 = 18,5$ m.w.c.

Negative conditions

DATA

- Unit: **30PHA-180STD**
- Temperature of inlet cold water: -1°C
- Temperature of outlet cold water: -4°C
- $\Delta T = +3°C$
- Outdoor air temperature: 30 °C
- Mono-ethylene glycol (MEG): 30%

DETERMINE

- Cooling capacity, glycol water flow, and pressure available.

SOLUTION

- Cooling capacity (table of capacities): $26,51 \times 860 = 22.799$ kcal/h
- Correction coefficient E1 = 1,0
- Corrected cooling capacity: $Pf_c = 22.799 \times 1,0 = 22.799$ kcal/h
- Cold water flow: $Q = 22.799 / 3 = 7.599$ l/h = 7,60 m³/h
- Correction coefficient E2 = 1,1
- Corrected flow: $Q_c = 7,60 \times 1,1 = 8,36$ m³/h
- Water flow resistance (according to the graph): $\Delta P = 8,0$ m.w.c.
- Correction coefficient E3 = 1,3
- Corrected water flow resistance: $\Delta P_c = 8,0 \times 1,3 = 10,4$ m.w.c.
- Pump's available pressure: 21,8 m.w.c.
- Unit's available pressure: $21,8 - 10,4 = 11,4$ m.w.c.

Anti-freeze protection with glycol water: Freezing point

The following table and curves feature the minimum glycol percentages required for the installation in accordance with the freezing point.

The pumps that incorporate the 30PAC/PHC units can work with any concentration of mono-ethylene glycol, albeit with a reduction in the available pressure due to the variation of glycol water flow. The pump must be changed for mono-propylene glycol (upon request).

Warning: the glycol concentration must keep the fluid at least 6°C below the outlet water temperature foreseen in the evaporator in order to allow a correct adjustment of the evaporator's minimum pressure regulation. If the concentration is below the necessary amount, there is a risk of freezing. Conversely, over-concentration could lead to a drop in performance.

Concentration	%	0	10	20	30	40	50
Mono-ethylene glycol (MEG)	°C	0	-3	-7	-13	-20	-29
Mono-propylene glycol (MPEG)	°C	0	-2	-5	-10	-15	-21

Note: The values are offered as a guide according to the standard characteristics of the MEG. These may vary based on the MEG manufacturer, which is why it is necessary to consult the manufacturer data in order to guarantee protection up to the desired temperature.

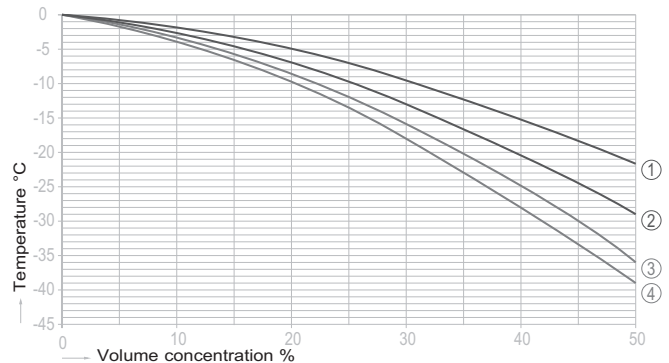

Minimum usage temperature:

- ① - Mono-propylene glycol
- ② - Mono-ethylene glycol

Freezing temperature:

- ③ - Mono-propylene glycol
- ④ - Mono-ethylene glycol

CORROSION BEHAVIOUR

Water content	Concentration (mg/l)	AISI 316	Copper
Organic substances		+	0
Electrical conductivity	< 500 μ S/cm	+	+
	> 500 μ S/cm	+	-
NH ₃	< 2	+	+
	2 - 20	+	0
	> 20	+	-
Chlorides *	< 300	+	+
	> 300	0	+
Sulphites, chloride-free	< 5	0	+
	> 5	0/-	0
Iron in solution	< 10	+	+
	> 10	+	0
Free carbonic acid	< 20	+	0
	20 - 50	+	-
	50	+	-
Manganese in solution	< 1	+	+
	> 1	+	0
pH value	< 6	0	+
	6 - 9	0/+	+
	> 9	+	0
Oxygen	< 2	+	+
	> 2	+	+
Sulphates	< 70	+	+
	70 - 300	+	0
	> 300	-	-

Corrosion problems may be present in the hydraulic circuit, and in particular the plate exchangers, if the characteristics of the water and its variations are not adequate.

It is recommended that the water filling the hydraulic circuits be filtered and treated, if necessary.

The units' hydraulic circuits are made of copper pipes. The exchanger plates are made of AISI-316 stainless steel, and the material used for soldering the plates is copper.

The following table indicates corrosion behaviour for copper and the AISI-316 stainless steel with regard to water with different compositions.

IMPORTANT: For open-circuit installations, if it is not possible to maintain the water conditions within the values indicated in the previous table, it will be necessary to install an exchanger that separates the unit's circuit from the water circuit to be treated by using materials compatible with these characteristics, whether stainless steel or titanium.

* Max. 60°C

+ Good resistance under normal conditions.

0 There may be corrosion problems, especially if other factors intervene.

- Not advisable.

COOLING RECOVERY CIRCUIT (OPTIONAL)

The system consists in a hot water supplying by an heat recovery system on the compressor discharge gas, on an auxiliary desuperheater exchanger.

On an heat pump model, the optional desuperheater can be used whatever the running mode, COOLING or HEATING.

This optional equipment is only available on request, and factory mounted.

Operating mode

The heat recovery is possible only if the machine is running, on COOLING mode or on HEATING mode.

For the same cooling or heating capacity, the desuperheater system allows a free heating of hot water with a reduction of the total input power of the machine.

Principle and precautions of hydraulic connection

In order to allow the unit to start up and to run under good conditions, the circuit must be as short as possible, and the water flow of the desuperheater must start slowly to normal operating condition, with a water flow equal to 10% of its standard value, and must be calculated for a hot water inlet temperature of +50°C.

Thus, it is recommended to have a hydraulic diagram making it possible to obtain very quickly a hot water at the inlet of the desuperheater (3 ways valve + controller + temperature sensor on the exchanger water inlet).

The controller set point must be adjusted to +50°C minimum.

The recovery circuit must be done in accordance with the standards in force and plan all of the necessary elements in a closed circuit: circulation pump (optionally supplied), expansion vessel, safety valve, mesh filter, filler, drainer, bleeders, thermometers, pressure gauges and cut-off and insulation valves.

The circulation pump can only work in a closed circuit. The command is performed from a thermostat located on the unit.

Attention: a detailed attention must carried with the selection of the expansion tank, because the recovery water circuit can reach the temperature of 120°C in the event of stopping of the circulator or non hot water consumption.

- Install heating elements on all pipes that could be exposed to freezing temperatures.



Installation diagram

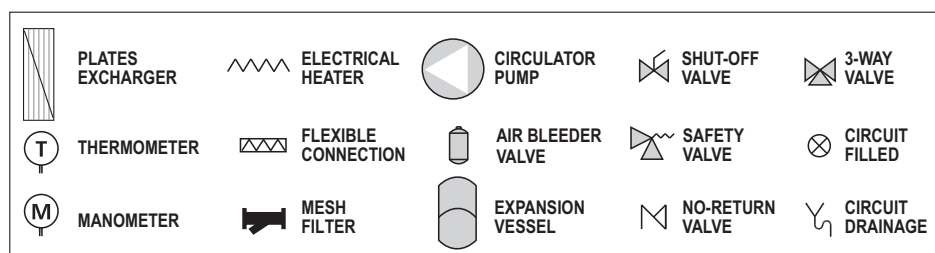
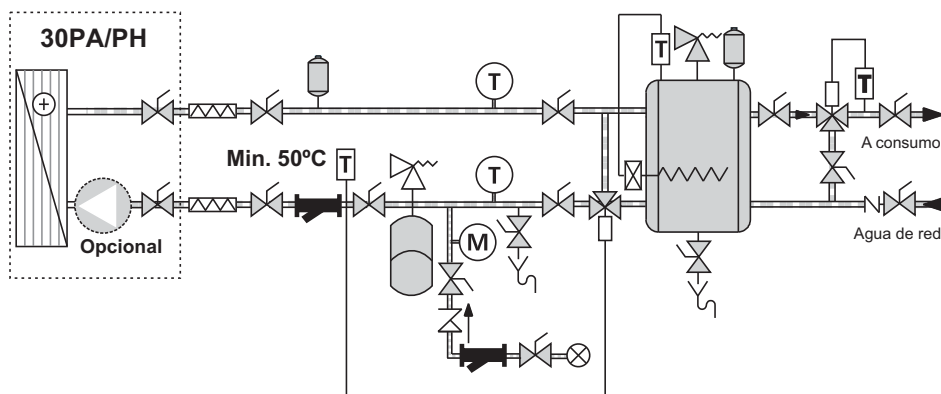

Technical characteristics of the recovery circuit

30PA/PH/PAC/PHC		STD version					HEE version				
		90STD	100STD	120STD	160STD	180STD	90HEE	100HEE	120HEE	160HEE	180HEE
Recovery capacity ① (kW)		4,4	5,2	6,2	8,1	8,9	4,5	5,2	6,3	7,7	8,8
Nominal water flow (m³/h)		0,38	0,45	0,53	0,70	0,76	0,39	0,44	0,54	0,67	0,76
Pressure drop (m.w.c.)		0,06	0,09	0,17	0,30	0,36	0,07	0,09	0,18	0,27	0,35
Cooling capacity (kW)		17,8	21,3	25,3	33,0	36,2	18,5	21,1	25,6	31,6	35,8
Power input (kW)		6,8	7,9	8,6	10,8	12,7	6,2	7,1	7,8	10,0	11,9
Hydraulic connections	Type	Threaded					Threaded				
	Diameter	1" M					1" M				
Pump (optional)	Type	Humid rotor					Humid rotor				
	Number	1					1				
	Motor output (kW)	0,05					0,05				
	Max. absorbed current (A)	0,4					0,4				
	Avail. pressure (m.w.c.) (max. pump speed) ②	5,54	5,45	5,35	5,15	5,07	5,52	5,46	5,34	5,19	5,07
Additional weight	Recovery circuit (kg)	5,3	5,3	6,8	6,8	6,8	5,3	5,3	6,8	6,8	6,8
	Pump (optional) (kg)	3,2					3,2				

① Capacity recovered by the desuperheater circuit for nominal conditions and recovery water at 50/60°C.

② The change of speed of the pump is made by a button that changes color according to the selected speed (blue: low; green: medium; yellow: high).

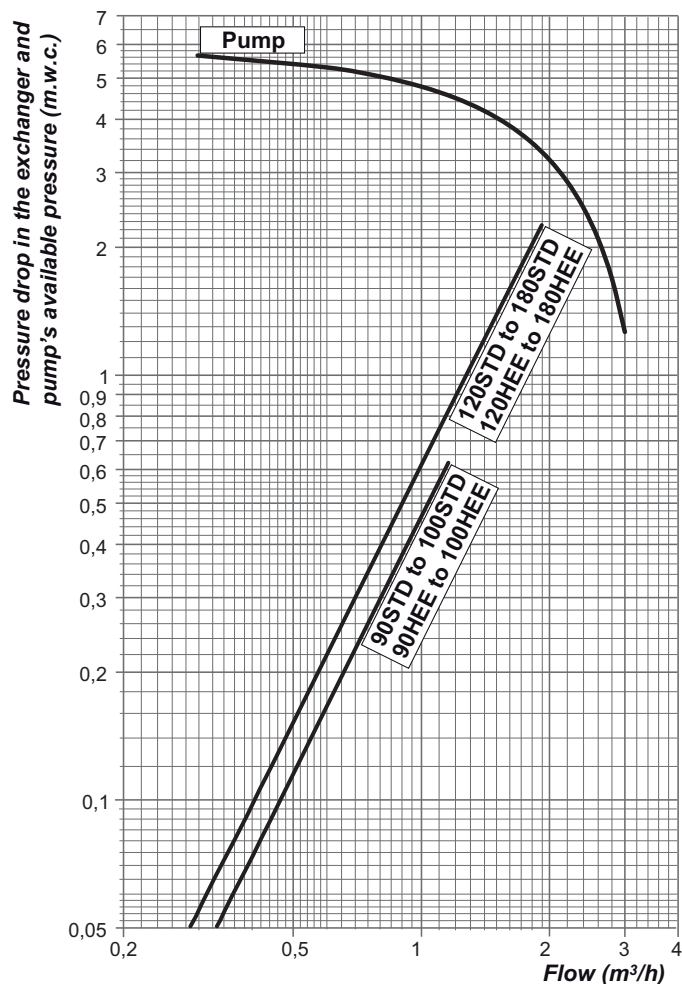



Ductable air-cooled scroll chillers and heat pumps

Capacity recovered by the recovery circuit with the STD version

30PA 30PH 30PAC 30PHC	Desuperh. water condition in °C	Temperature of outlet cold water in °C	Outdoor air temperature in °C																			
			25				30				35				40				46			
			Pf kW	Pa kW	Pcr kW	Qar m³/h	Pf kW	Pa kW	Pcr kW	Qar m³/h	Pf kW	Pa kW	Pcr kW	Qar m³/h	Pf kW	Pa kW	Pcr kW	Qar m³/h	Pf kW	Pa kW	Pcr kW	Qar m³/h
90STD	45 / 55	5	19,1	5,6	2,7	0,2	17,9	6,1	3,6	0,3	16,5	6,7	4,7	0,4	15,2	7,3	6,2	0,5	13,7	8,0	8,4	0,7
		7	20,5	5,7	2,9	0,2	19,2	6,3	3,9	0,3	17,8	6,8	5,1	0,4	16,4	7,5	6,7	0,6	14,8	8,2	9,0	0,8
		12	23,5	6,1	3,3	0,3	22,1	6,6	4,4	0,4	20,4	7,2	5,8	0,5	18,9	7,8	7,7	0,7	17,0	8,5	10,4	0,9
		15	25,4	6,3	3,5	0,3	23,8	6,8	4,8	0,4	22,1	7,4	6,3	0,5	20,4	8,0	8,4	0,7	18,4	8,7	11,2	1,0
	50 / 60	5	19,1	5,6	2,2	0,2	17,9	6,1	3,0	0,3	16,5	6,7	4,1	0,4	15,2	7,3	5,0	0,4	13,7	8,0	7,2	0,6
		7	20,5	5,7	2,4	0,2	19,2	6,3	3,2	0,3	17,8	6,8	4,4	0,4	16,4	7,5	5,4	0,5	14,8	8,2	7,7	0,7
		12	23,5	6,1	2,7	0,2	22,1	6,6	3,7	0,3	20,4	7,2	5,0	0,4	18,9	7,8	6,2	0,5	17,0	8,5	8,9	0,8
		15	25,4	6,3	2,9	0,3	23,8	6,8	4,0	0,4	22,1	7,4	5,4	0,5	20,4	8,0	6,7	0,6	18,4	8,7	9,6	0,8
100STD	45 / 55	5	22,6	6,5	3,1	0,3	21,4	7,1	4,3	0,4	20,0	7,7	5,7	0,5	18,5	8,4	7,6	0,7	16,8	9,3	10,2	0,9
		7	24,2	6,7	3,4	0,3	22,8	7,3	4,6	0,4	21,3	7,9	6,1	0,5	19,7	8,6	8,1	0,7	17,8	9,5	10,8	0,9
		12	27,8	7,1	3,9	0,3	26,1	7,7	5,2	0,5	24,3	8,3	6,9	0,6	22,5	9,0	9,2	0,8	20,3	9,9	12,4	1,1
		15	30,0	7,3	4,2	0,4	28,2	7,9	5,7	0,5	26,3	8,6	7,5	0,7	24,4	9,2	10,0	0,9	22,0	10,1	13,4	1,2
	50 / 60	5	22,6	6,5	2,6	0,2	21,4	7,1	3,6	0,3	20,0	7,7	4,9	0,4	18,5	8,4	6,1	0,5	16,8	9,3	8,7	0,8
		7	24,2	6,7	2,8	0,2	22,8	7,3	3,8	0,3	21,3	7,9	5,2	0,5	19,7	8,6	6,5	0,6	17,8	9,5	9,3	0,8
		12	27,8	7,1	3,2	0,3	26,1	7,7	4,4	0,4	24,3	8,3	6,0	0,5	22,5	9,0	7,4	0,6	20,3	9,9	10,6	0,9
		15	30,0	7,3	3,5	0,3	28,2	7,9	4,8	0,4	26,3	8,6	6,5	0,6	24,4	9,2	8,0	0,7	22,0	10,1	11,5	1,0
120STD	45 / 55	5	26,8	7,0	3,7	0,3	25,3	7,7	5,1	0,4	23,7	8,4	6,8	0,6	22,0	9,2	9,0	0,8	19,9	10,2	12,1	1,0
		7	28,7	7,2	4,0	0,3	27,0	7,8	5,4	0,5	25,3	8,6	7,2	0,6	23,5	9,3	9,6	0,8	21,3	10,3	13,0	1,1
		12	33,0	7,5	4,6	0,4	31,1	8,2	6,2	0,5	29,1	9,0	8,3	0,7	27,1	9,7	11,1	1,0	24,5	10,7	15,0	1,3
		15	35,7	7,8	5,0	0,4	33,7	8,5	6,8	0,6	31,5	9,2	9,0	0,8	29,5	10,0	12,1	1,0	26,6	11,0	16,2	1,4
	50 / 60	5	26,8	7,0	3,1	0,3	25,3	7,7	4,3	0,4	23,7	8,4	5,8	0,5	22,0	9,2	7,3	0,6	19,9	10,2	10,4	0,9
		7	28,7	7,2	3,3	0,3	27,0	7,8	4,6	0,4	25,3	8,6	6,2	0,5	23,5	9,3	7,8	0,7	21,3	10,3	11,1	1,0
		12	33,0	7,5	3,8	0,3	31,1	8,2	5,3	0,5	29,1	9,0	7,1	0,6	27,1	9,7	8,9	0,8	24,5	10,7	12,8	1,1
		15	35,7	7,8	4,1	0,4	33,7	8,5	5,7	0,5	31,5	9,2	7,7	0,7	29,5	10,0	9,7	0,8	26,6	11,0	13,9	1,2
160STD	45 / 55	5	34,7	8,7	4,8	0,4	32,8	9,6	6,6	0,6	30,8	10,6	8,8	0,8	28,6	11,6	11,7	1,0	25,9	13,0	15,8	1,4
		7	37,2	8,9	5,2	0,4	35,1	9,8	7,0	0,6	33,0	10,8	9,4	0,8	30,6	11,8	12,5	1,1	27,9	13,1	17,0	1,5
		12	42,7	9,3	5,9	0,5	40,3	10,2	8,1	0,7	37,8	11,2	10,8	0,9	35,2	12,2	14,4	1,2	32,1	13,5	19,6	1,7
		15	46,2	9,6	6,4	0,6	43,6	10,5	8,8	0,8	40,7	11,4	11,6	1,0	38,1	12,5	15,6	1,3	34,8	13,8	21,2	1,8
	50 / 60	5	34,7	8,7	4,0	0,3	32,8	9,6	5,5	0,5	30,8	10,6	7,6	0,7	28,6	11,6	9,4	0,8	25,9	13,0	13,5	1,2
		7	37,2	8,9	4,3	0,4	35,1	9,8	5,9	0,5	33,0	10,8	8,1	0,7	30,6	11,8	10,1	0,9	27,9	13,1	14,5	1,3
		12	42,7	9,3	4,9	0,4	40,3	10,2	6,8	0,6	37,8	11,2	9,3	0,8	35,2	12,2	11,6	1,0	32,1	13,5	16,7	1,4
		15	46,2	9,6	5,3	0,5	43,6	10,5	7,4	0,6	40,7	11,4	10,0	0,9	38,1	12,5	12,6	1,1	34,8	13,8	18,2	1,6
180STD	45 / 55	5	38,6	10,3	5,4	0,5	36,2	11,3	7,3	0,6	33,8	12,4	9,7	0,8	31,3	13,6	12,8	1,1	28,2	15,2	17,2	1,5
		7	41,2	10,5	5,7	0,5	38,8	11,6	7,8	0,7	36,2	12,7	10,3	0,9	33,5	13,8	13,7	1,2	30,2	15,4	18,4	1,6
		12	47,6	11,0	6,6	0,6	44,6	12,0	8,9	0,8	41,6	13,1	11,9	1,0	38,6	14,3	15,8	1,4	34,9	15,9	21,3	1,8
		15	51,5	11,2	7,2	0,6	48,4	12,3	9,7	0,8	45,2	13,5	12,9	1,1	41,7	14,6	17,1	1,5	37,6	16,1	22,9	2,0
	50 / 60	5	38,6	10,3	4,4	0,4	36,2	11,3	6,1	0,5	33,8	12,4	8,3	0,7	31,3	13,6	10,3	0,9	28,2	15,2	14,7	1,3
		7	41,2	10,5	4,7	0,4	38,8	11,6	6,5	0,6	36,2	12,7	8,9	0,8	33,5	13,8	11,1	1,0	30,2	15,4	15,8	1,4
		12	47,6	11,0	5,5	0,5	44,6	12,0	7,5	0,7	41,6	13,1	10,2	0,9	38,6	14,3	12,7	1,1	34,9	15,9	18,2	1,6
		15	51,5	11,2	5,9	0,5	48,4	12,3	8,2	0,7	45,2	13,5	11,1	1,0	41,7	14,6	13,8	1,2	37,6	16,1	19,6	1,7

Pf: Gross cooling capacity in kW

Pa: Compressor power input in kW

Pcr: Heating capacity recovered in the hot gases recuperator in kW

Qar: Water flow in the recuperator

Can be interpolated among the values of the table, never extrapolated

Ductable air-cooled scroll chillers and heat pumps

Capacity recovered by the recovery circuit with the HEE version

30PA 30PH 30PAC 30PHC	Desuperh. water condition in °C	Temperature of outlet cold water in °C	Outdoor air temperature in °C																			
			25				30				35				40				46			
			Pf kW	Pa kW	Pcr kW	Qar m³/h	Pf kW	Pa kW	Pcr kW	Qar m³/h	Pf kW	Pa kW	Pcr kW	Qar m³/h	Pf kW	Pa kW	Pcr kW	Qar m³/h	Pf kW	Pa kW	Pcr kW	Qar m³/h
90HEE	45 / 55	5	19,7	5,0	2,7	0,2	18,5	5,5	3,7	0,3	17,3	6,1	4,9	0,4	16,0	6,7	6,5	0,6	13,9	7,5	8,5	0,7
		7	21,0	5,1	2,9	0,3	19,8	5,6	4,0	0,3	18,5	6,2	5,3	0,5	17,0	6,8	7,0	0,6	14,8	7,6	9,0	0,8
		12	24,2	5,4	3,4	0,3	22,7	5,9	4,6	0,4	21,2	6,5	6,1	0,5	19,6	7,1	8,0	0,7	17,7	7,9	10,8	0,9
		15	26,1	5,6	3,6	0,3	24,6	6,1	4,9	0,4	23,0	6,7	6,6	0,6	21,3	7,3	8,7	0,7	19,2	8,1	11,7	1,0
	50 / 60	5	19,7	5,0	2,3	0,2	18,5	5,5	3,1	0,3	17,3	6,1	4,2	0,4	16,0	6,7	5,3	0,5	13,9	7,5	7,3	0,6
		7	21,0	5,1	2,4	0,2	19,8	5,6	3,3	0,3	18,5	6,2	4,5	0,4	17,0	6,8	5,6	0,5	14,8	7,6	7,7	0,7
		12	24,2	5,4	2,8	0,2	22,7	5,9	3,8	0,3	21,2	6,5	5,2	0,4	19,6	7,1	6,5	0,6	17,7	7,9	9,2	0,8
		15	26,1	5,6	3,0	0,3	24,6	6,1	4,1	0,4	23,0	6,7	5,6	0,5	21,3	7,3	7,0	0,6	19,2	8,1	10,0	0,9
100HEE	45 / 55	5	22,4	5,7	3,1	0,3	21,1	6,3	4,2	0,4	19,7	6,9	5,6	0,5	18,3	7,7	7,5	0,6	16,6	8,6	10,1	0,9
		7	23,9	5,8	3,3	0,3	22,4	6,4	4,5	0,4	21,1	7,1	6,0	0,5	19,6	7,8	8,0	0,7	17,8	8,7	10,8	0,9
		12	27,4	6,2	3,8	0,3	25,8	6,8	5,2	0,4	24,1	7,4	6,9	0,6	22,5	8,1	9,2	0,8	20,5	9,0	12,5	1,1
		15	29,5	6,4	4,1	0,4	27,8	7,0	5,6	0,5	26,1	7,7	7,4	0,6	24,4	8,3	10,0	0,9	22,2	9,3	13,5	1,2
	50 / 60	5	22,4	5,7	2,6	0,2	21,1	6,3	3,6	0,3	19,7	6,9	4,8	0,4	18,3	7,7	6,1	0,5	16,6	8,6	8,7	0,7
		7	23,9	5,8	2,7	0,2	22,4	6,4	3,8	0,3	21,1	7,1	5,2	0,4	19,6	7,8	6,5	0,6	17,8	8,7	9,3	0,8
		12	27,4	6,2	3,1	0,3	25,8	6,8	4,4	0,4	24,1	7,4	5,9	0,5	22,5	8,1	7,4	0,6	20,5	9,0	10,7	0,9
		15	29,5	6,4	3,4	0,3	27,8	7,0	4,7	0,4	26,1	7,7	6,4	0,6	24,4	8,3	8,0	0,7	22,2	9,3	11,6	1,0
120HEE	45 / 55	5	27,2	6,2	3,8	0,3	25,6	6,9	5,1	0,4	23,9	7,7	6,8	0,6	22,1	8,5	9,0	0,8	19,8	9,6	12,1	1,0
		7	29,1	6,3	4,0	0,3	27,4	7,0	5,5	0,5	25,6	7,8	7,3	0,6	23,7	8,6	9,7	0,8	21,3	9,7	13,0	1,1
		12	33,5	6,6	4,6	0,4	31,6	7,3	6,3	0,5	29,5	8,1	8,4	0,7	27,4	8,9	11,2	1,0	24,7	10,0	15,1	1,3
		15	36,3	6,8	5,0	0,4	34,2	7,5	6,9	0,6	32,1	8,3	9,2	0,8	29,7	9,1	12,2	1,0	27,0	10,2	16,4	1,4
	50 / 60	5	27,2	6,2	3,1	0,3	25,6	6,9	4,3	0,4	23,9	7,7	5,9	0,5	22,1	8,5	7,3	0,6	19,8	9,6	10,4	0,9
		7	29,1	6,3	3,3	0,3	27,4	7,0	4,6	0,4	25,6	7,8	6,3	0,5	23,7	8,6	7,8	0,7	21,3	9,7	11,1	1,0
		12	33,5	6,6	3,9	0,3	31,6	7,3	5,3	0,5	29,5	8,1	7,3	0,6	27,4	8,9	9,0	0,8	24,7	10,0	12,9	1,1
		15	36,3	6,8	4,2	0,4	34,2	7,5	5,8	0,5	32,1	8,3	7,9	0,7	29,7	9,1	9,8	0,8	27,0	10,2	14,1	1,2
160HEE	45 / 55	5	33,6	8,1	4,7	0,4	31,7	8,9	6,4	0,5	29,6	9,8	8,5	0,7	27,4	10,8	11,2	1,0	23,4	12,1	14,3	1,2
		7	35,8	8,3	5,0	0,4	33,8	9,1	6,8	0,6	31,6	10,0	9,0	0,8	29,3	11,0	12,0	1,0	26,2	12,3	16,0	1,4
		12	41,3	8,7	5,7	0,5	38,8	9,6	7,8	0,7	37,3	10,5	10,7	0,9	33,7	11,5	13,8	1,2	30,3	12,7	18,5	1,6
		15	44,7	9,0	6,2	0,5	42,1	9,8	8,4	0,7	39,3	10,7	11,2	1,0	36,5	11,7	14,9	1,3	32,9	13,0	20,1	1,7
	50 / 60	5	33,6	8,1	3,9	0,3	31,7	8,9	5,3	0,5	29,6	9,8	7,3	0,6	27,4	10,8	9,0	0,8	23,4	12,1	12,2	1,0
		7	35,8	8,3	4,1	0,4	33,8	9,1	5,7	0,5	31,6	10,0	7,7	0,7	29,3	11,0	9,7	0,8	26,2	12,3	13,7	1,2
		12	41,3	8,7	4,7	0,4	38,8	9,6	6,6	0,6	37,3	10,5	9,2	0,8	33,7	11,5	11,1	1,0	30,3	12,7	15,8	1,4
		15	44,7	9,0	5,1	0,4	42,1	9,8	7,1	0,6	39,3	10,7	9,6	0,8	36,5	11,7	12,0	1,0	32,9	13,0	17,2	1,5
180HEE	45 / 55	5	38,0	9,7	5,3	0,5	35,8	10,7	7,2	0,6	33,6	11,7	9,6	0,8	31,2	12,8	12,7	1,1	26,4	14,2	16,1	1,4
		7	40,6	9,9	5,6	0,5	38,3	10,9	7,7	0,7	35,8	11,9	10,2	0,9	33,3	13,1	13,6	1,2	29,5	14,5	18,0	1,5
		12	46,7	10,4	6,5	0,6	44,0	11,4	8,8	0,8	41,2	12,4	11,8	1,0	38,2	13,6	15,6	1,3	34,5	15,0	21,0	1,8
		15	50,6	10,8	7,0	0,6	47,6	11,7	9,6	0,8	44,6	12,8	12,7	1,1	41,4	13,9	16,9	1,5	37,5	15,3	22,8	2,0
	50 / 60	5	38,0	9,7	4,4	0,4	35,8	10,7	6,0	0,5	33,6	11,7	8,2	0,7	31,2	12,8	10,3	0,9	26,4	14,2	13,8	1,2
		7	40,6	9,9	4,7	0,4	38,3	10,9	6,5	0,6	35,8	11,9	8,8	0,8	33,3	13,1	11,0	0,9	29,5	14,5	15,4	1,3
		12	46,7	10,4	5,4	0,5	44,0	11,4	7,4	0,6	41,2	12,4	10,1	0,9	38,2	13,6	12,6	1,1	34,5	15,0	18,0	1,5
		15	50,6	10,8	5,8	0,5	47,6	11,7	8,0	0,7	44,6	12,8	10,9	0,9	41,4	13,9	13,6	1,2	37,5	15,3	19,5	1,7

Pf: Gross cooling capacity in kW

Pa: Compressor power input in kW

Pcr: Heating capacity recovered in the hot gases recuperator in kW

Qar: Water flow in the recuperator

Can be interpolated among the values of the table, never extrapolated

DIMENSION SCHEMES FOR THE STD VERSION

30PA/PH/PAC/PHC - 90STD / 100STD with HORIZONTAL supply, M00 assembly (mm)

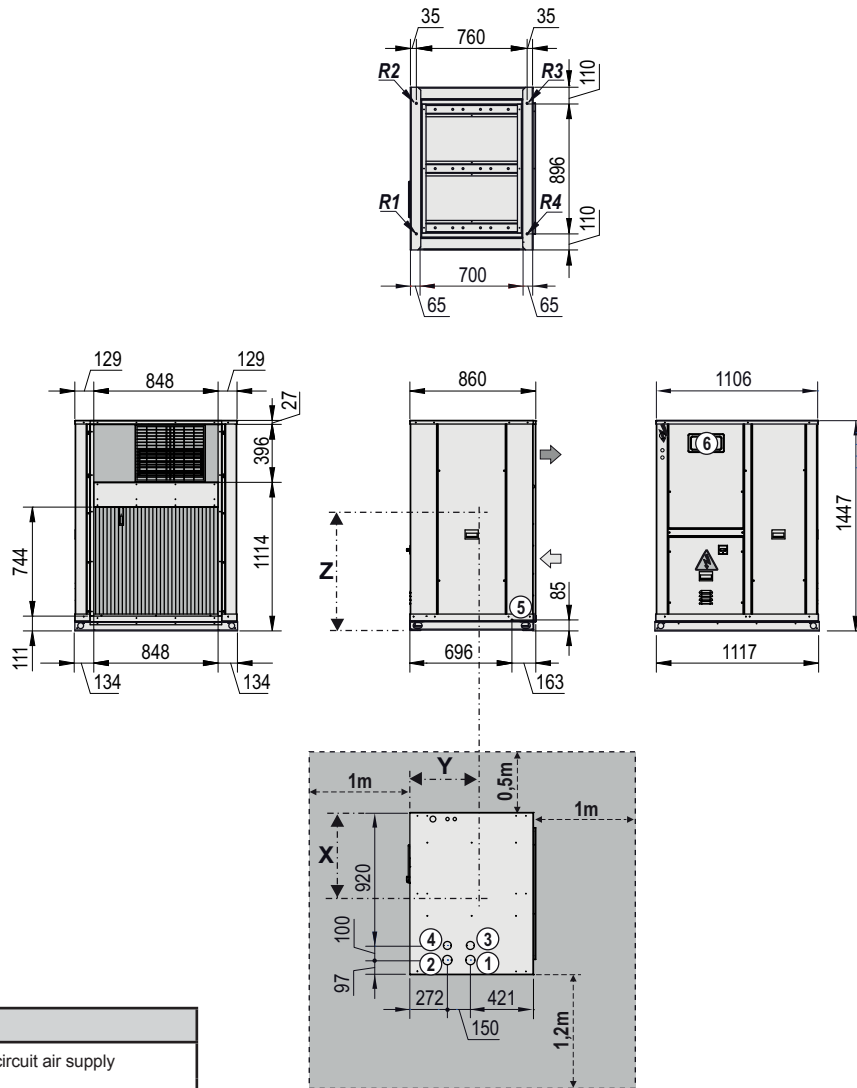

LEGEND

- HORIZONTAL outdoor circuit air supply
- Outdoor circuit air return
- Electric panel
- Electric power supply
- Door switch
- ① Water inlet to the indoor circuit
- ② Water outlet from the indoor circuit
- ③ Water outlet from the recovery circuit (optional)
- ④ Water inlet to the recovery circuit (optional)
- ⑤ Condensate outlet: trunk 3/4" M
- ⑥ Collapsible window for access to control panel (it protrudes 12 mm)

Note: the hydraulic connections ①② protrude 58 mm

Anti-vibration anchoring: rivet nut M10

Clear space to be observed for maintenance operations and unit start-up

Models	Centre of gravity coordinates (mm)			Reactions in the supports (kg)					
	X	Y	Z	Weight	R1	R2	R3	R4	
30PA 30PH	90STD	453	384	528	306	66	101	87	52
	100STD	488	398	576	315	69	93	84	60
30PAC 30PHC	90STD	517	396	577	335	81	97	86	71
	100STD	515	402	574	345	82	99	90	73

DIMENSION SCHEMES FOR THE STD VERSION

30PA/PH/PAC/PHC - 90STD / 100STD with VERTICAL supply, M01 assembly (mm)

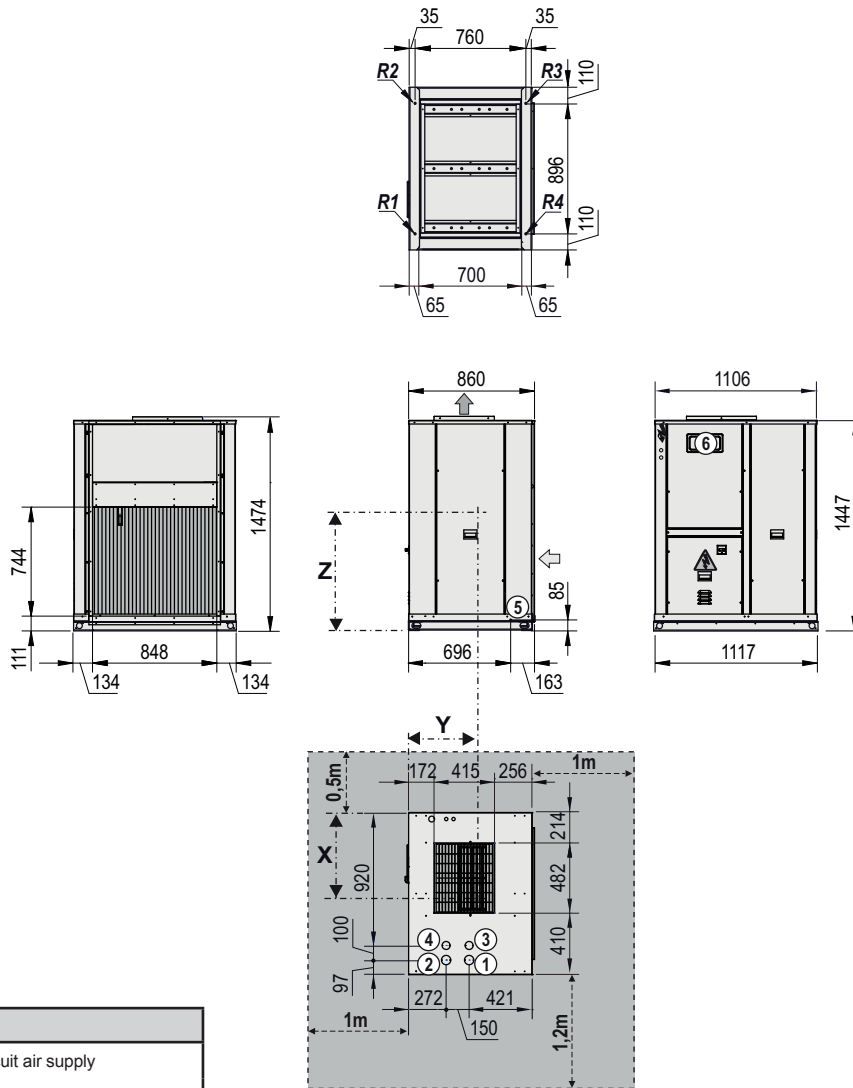

LEGEND

- VERTICAL outdoor circuit air supply
- Outdoor circuit air return
- Electric panel
- Electric power supply
- Door switch
- ① Water inlet to the indoor circuit
- ② Water outlet from the indoor circuit
- ③ Water outlet from the recovery circuit (optional)
- ④ Water inlet to the recovery circuit (optional)
- ⑤ Condensate outlet: trunk 3/4" M
- ⑥ Collapsible window for access to control panel (it protrudes 12 mm)

Note: the hydraulic connections ①② protrude 58 mm

Anti-vibration anchoring: rivet nut M10

Clear space to be observed for maintenance operations and unit start-up

Models		Centre of gravity coordinates (mm)			Reactions in the supports (kg)				
		X	Y	Z	Weight	R1	R2	R3	R4
30PA 30PH	90STD	453	384	528	306	66	101	87	52
	100STD	488	398	576	315	69	93	84	60
30PAC 30PHC	90STD	517	396	577	335	81	97	86	71
	100STD	515	402	574	345	82	99	90	73

DIMENSION SCHEMES FOR THE STD VERSION

30PA/PH/PAC/PHC - 120STD / 160STD / 180STD with HORIZONTAL supply, M00 assembly (mm)

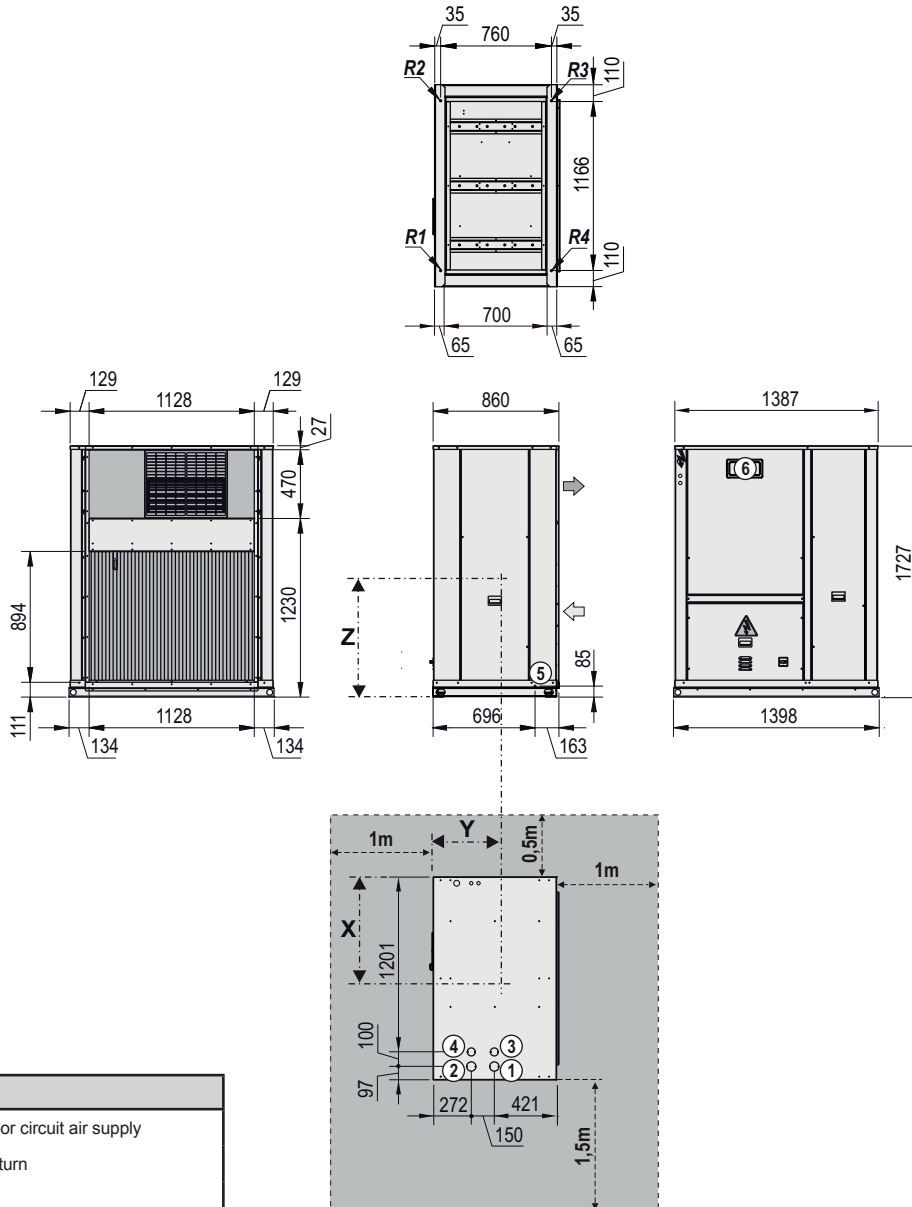

LEGEND

- HORIZONTAL outdoor circuit air supply
- Outdoor circuit air return
- Electric panel
- Electric power supply
- Door switch
- ① Water inlet to the indoor circuit
- ② Water outlet from the indoor circuit
- ③ Water outlet from the recovery circuit (optional)
- ④ Water inlet to the recovery circuit (optional)
- ⑤ Condensate outlet: trunk 3/4" M
- ⑥ Collapsible window for access to control panel (it protrudes 12 mm)

Note: the hydraulic connections ①② protrude 58 mm

Anti-vibration anchoring: rivet nut M10

Clear space to be observed for maintenance operations and unit start-up

Models		Centre of gravity coordinates (mm)			Reactions in the supports (kg)				
		X	Y	Z	Weight	R1	R2	R3	R4
30PA 30PH	120STD	625	399	676	379	89	112	101	77
	160STD	619	400	666	397	92	119	107	79
	180STD	625	397	674	396	93	119	105	79
30PAC 30PHC	120STD	645	402	673	410	99	117	107	87
	160STD	639	402	663	428	102	124	113	90
	180STD	646	400	669	429	104	123	111	91

DIMENSION SCHEMES FOR THE STD VERSION

30PA/PH/PAC/PHC - 120STD / 160STD / 180STD with VERTICAL supply, M01 assembly (mm)

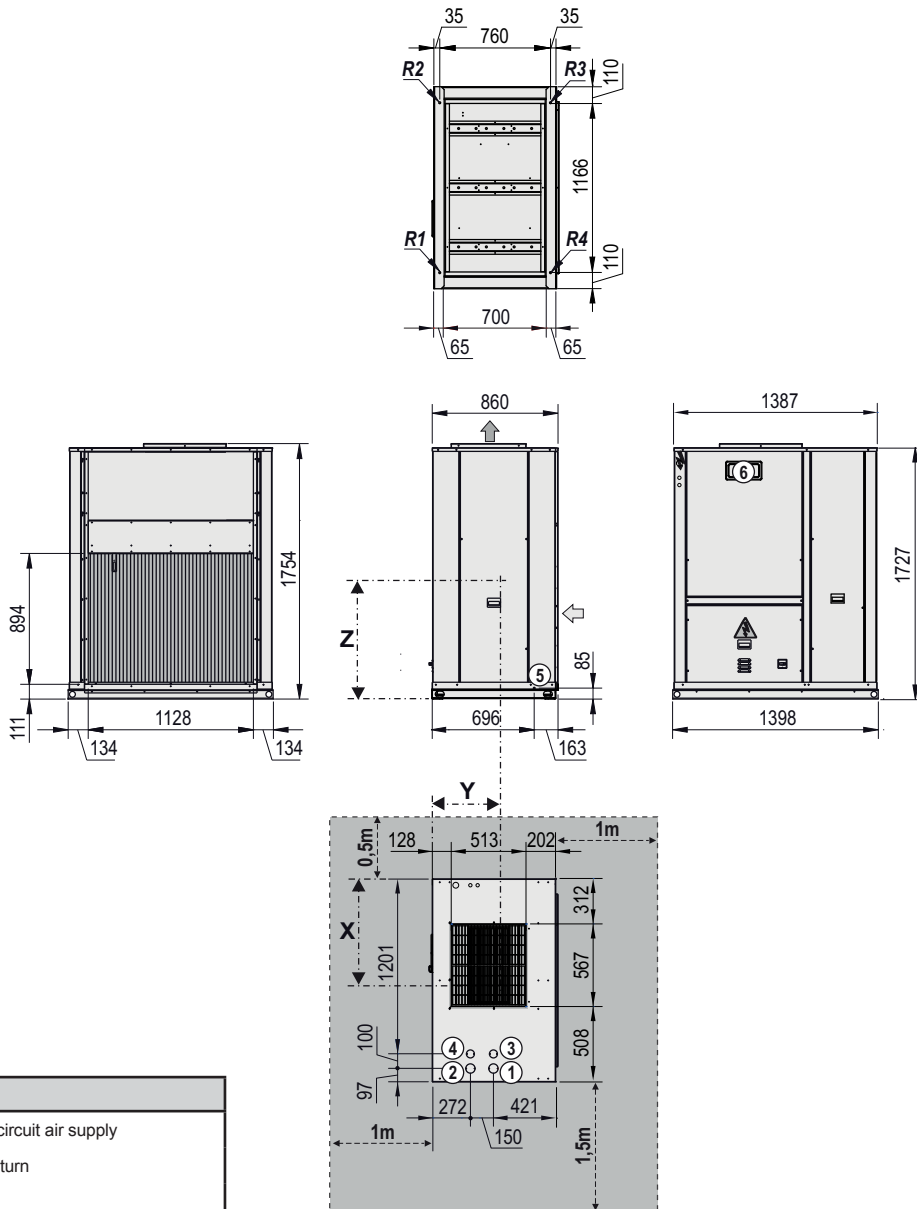

LEGEND

- VERTICAL outdoor circuit air supply
- Outdoor circuit air return
- Electric panel
- Electric power supply
- Door switch
- ① Water inlet to the indoor circuit
- ② Water outlet from the indoor circuit
- ③ Water outlet from the recovery circuit (optional)
- ④ Water inlet to the recovery circuit (optional)
- ⑤ Condensate outlet: trunk 3/4" M
- ⑥ Collapsible window for access to control panel (it protrudes 12 mm)

Note: the hydraulic connections ①② protrude 58 mm
Anti-vibration anchoring: rivet nut M10

Clear space to be observed for maintenance operations and unit start-up

Models		Centre of gravity coordinates (mm)			Reactions in the supports (kg)				
		X	Y	Z	Weight	R1	R2	R3	R4
30PA 30PH	120STD	625	399	676	379	89	112	101	77
	160STD	619	400	666	397	92	119	107	79
	180STD	625	397	674	396	93	119	105	79
30PAC 30PHC	120STD	645	402	673	410	99	117	107	87
	160STD	639	402	663	428	102	124	113	90
	180STD	646	400	669	429	104	123	111	91

DIMENSION SCHEMES FOR THE STD VERSION

Condensation pressure control damper (mm)

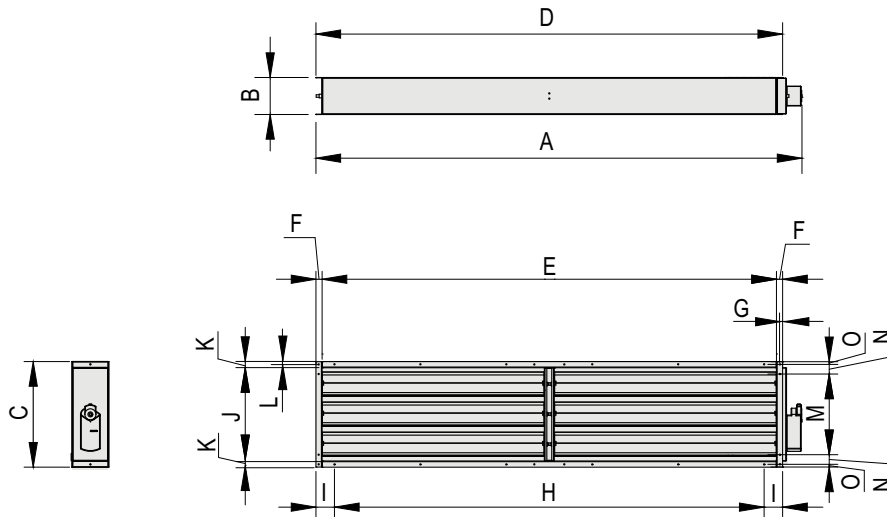

30PA/PH/PAC/PHC	Assembly	Servos per damper	Total weight (kg)	A	B	C	D	E	F	G	H	I	J	K	L	M	N	O
90STD / 100STD	M00	1	13	978	150	446	895	845	25	11	3 x 266	49	396	25	11	296	64	11
120STD to 180STD		1	17	1258	150	520	1175	1125	25	11	4 x 269	49	470	25	11	370	64	11
90STD / 100STD	M01	1	13	633	150 (*)	428	550	500	25	11	1 x 400	75	378	25	11	278	64	11
120STD to 180STD		1	17	733	150 (*)	550	650	600	25	11	2 x 250	75	500	25	11	400	64	11

(*) In the case of vertical discharge (M01 assembly), the damper incorporates a frame (60 mm height) to fit the damper to the fan supply. This frame may be removed for duct installation.

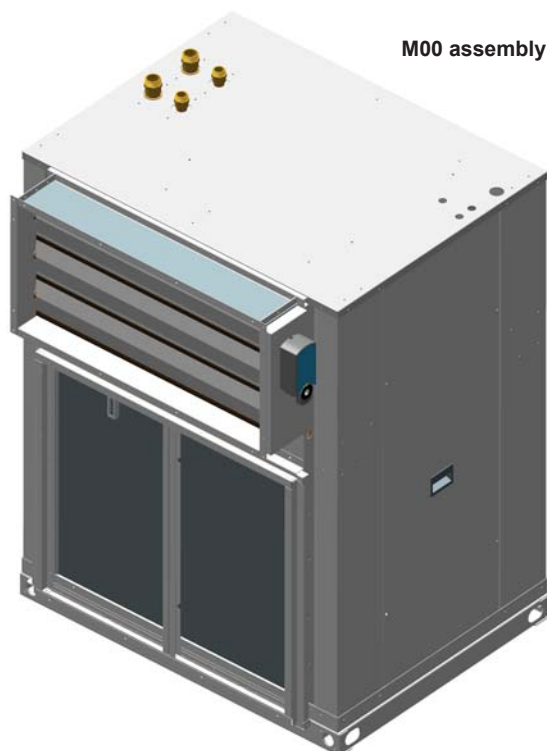

M00 assembly

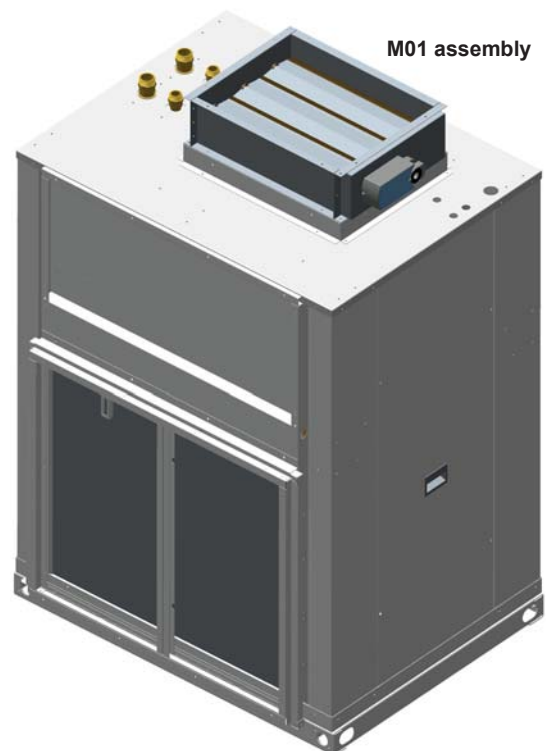





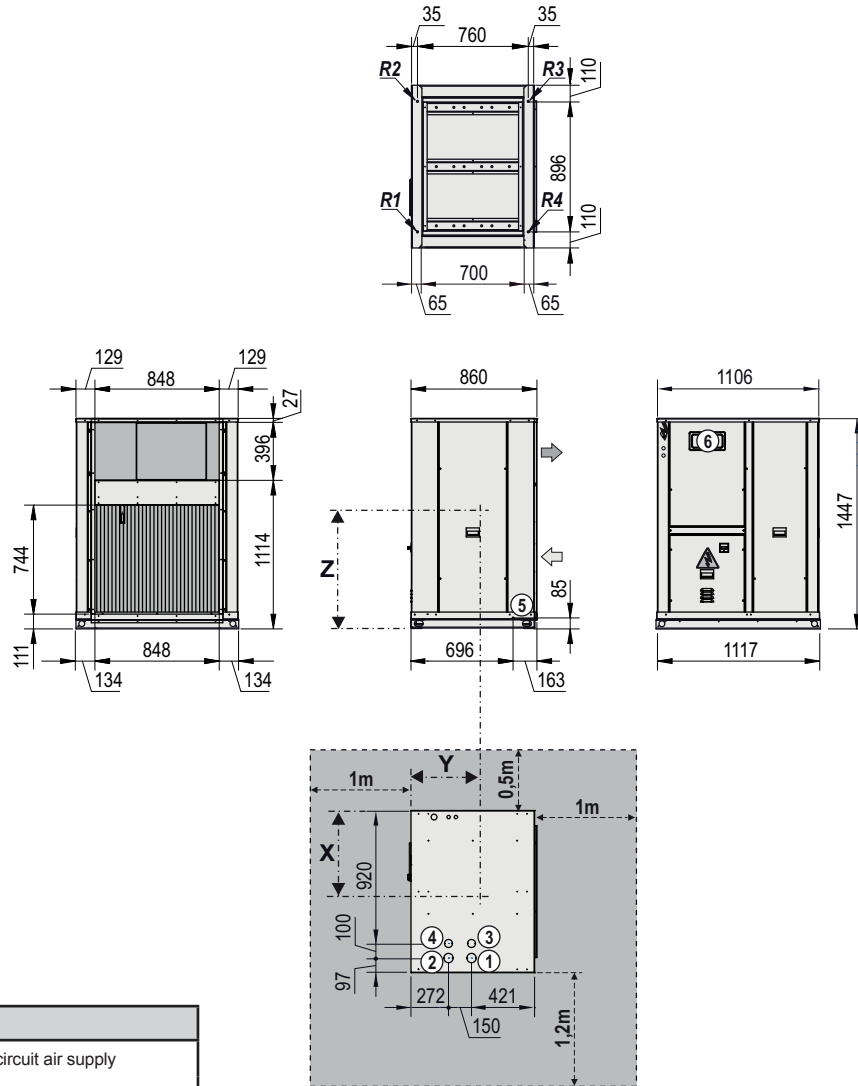

M01 assembly

Note: By default this damper is sent attached to the unit. For duct installation it is necessary to unscrew from the unit and disconnect the electrical supply of the servomotor.

DIMENSION SCHEMES FOR THE HEE VERSION

30PA/PH/PAC/PHC - 90HEE with HORIZONTAL supply, M00 assembly (mm)



LEGEND	
	HORIZONTAL outdoor circuit air supply
	Outdoor circuit air return
	Electric panel
	Electric power supply
	Door switch
①	Water inlet to the indoor circuit
②	Water outlet from the indoor circuit
③	Water outlet from the recovery circuit (optional)
④	Water inlet to the recovery circuit (optional)
⑤	Condensate outlet: trunk 3/4" M
⑥	Collapsible window for access to control panel (it protrudes 12 mm)
Note: the hydraulic connections ①② protrude 58 mm	
Anti-vibration anchoring: rivet nut M10	
	Clear space to be observed for maintenance operations and unit start-up

Models		Centre of gravity coordinates (mm)			Reactions in the supports (kg)				
		X	Y	Z	Weight	R1	R2	R3	R4
30PA/PH	90HEE	502	422	614	298	64	100	85	50
30PAC/PHC	90HEE	538	427	599	327	77	84	87	79

DIMENSION SCHEMES FOR THE HEE VERSION

30PA/PH/PAC/PHC - 90HEE with VERTICAL supply, M01 assembly (mm)

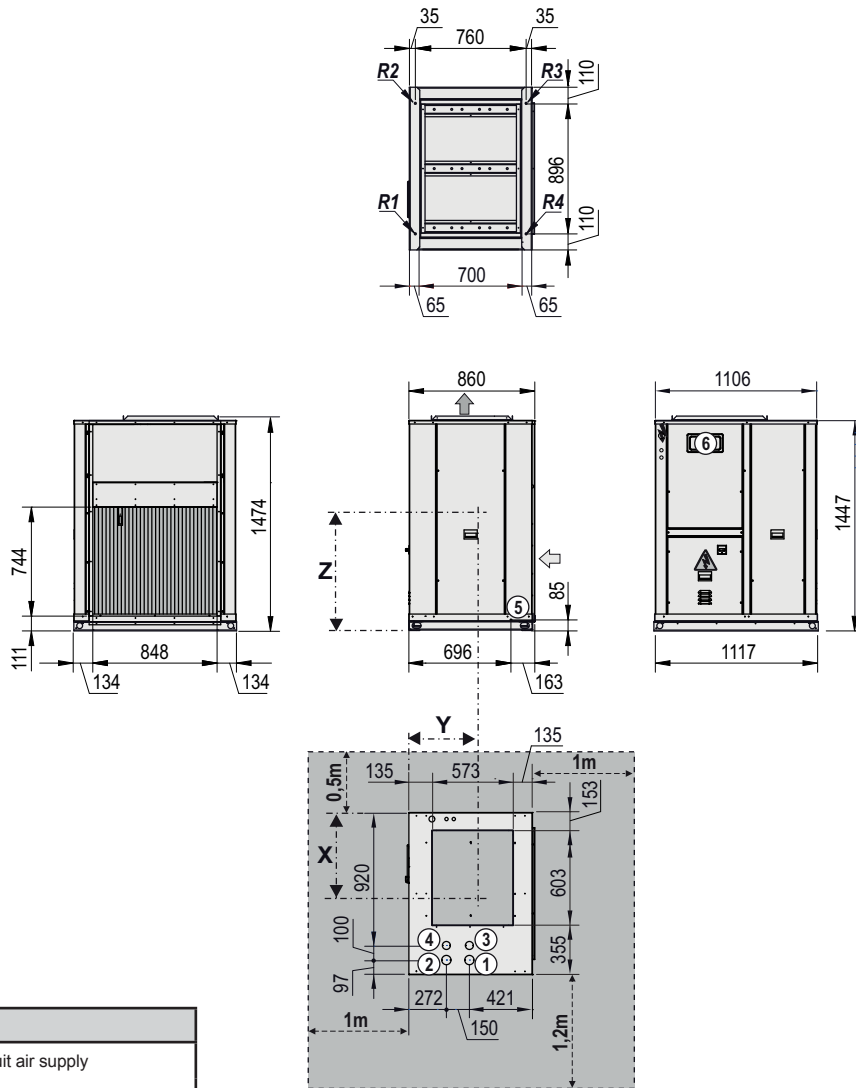

LEGEND

- VERTICAL outdoor circuit air supply
- Outdoor circuit air return
- Electric panel
- Electric power supply
- Door switch
- ① Water inlet to the indoor circuit
- ② Water outlet from the indoor circuit
- ③ Water outlet from the recovery circuit (optional)
- ④ Water inlet to the recovery circuit (optional)
- ⑤ Condensate outlet: trunk 3/4" M
- ⑥ Collapsible window for access to control panel (it protrudes 12 mm)

Note: the hydraulic connections ①② protrude 58 mm

Anti-vibration anchoring: rivet nut M10





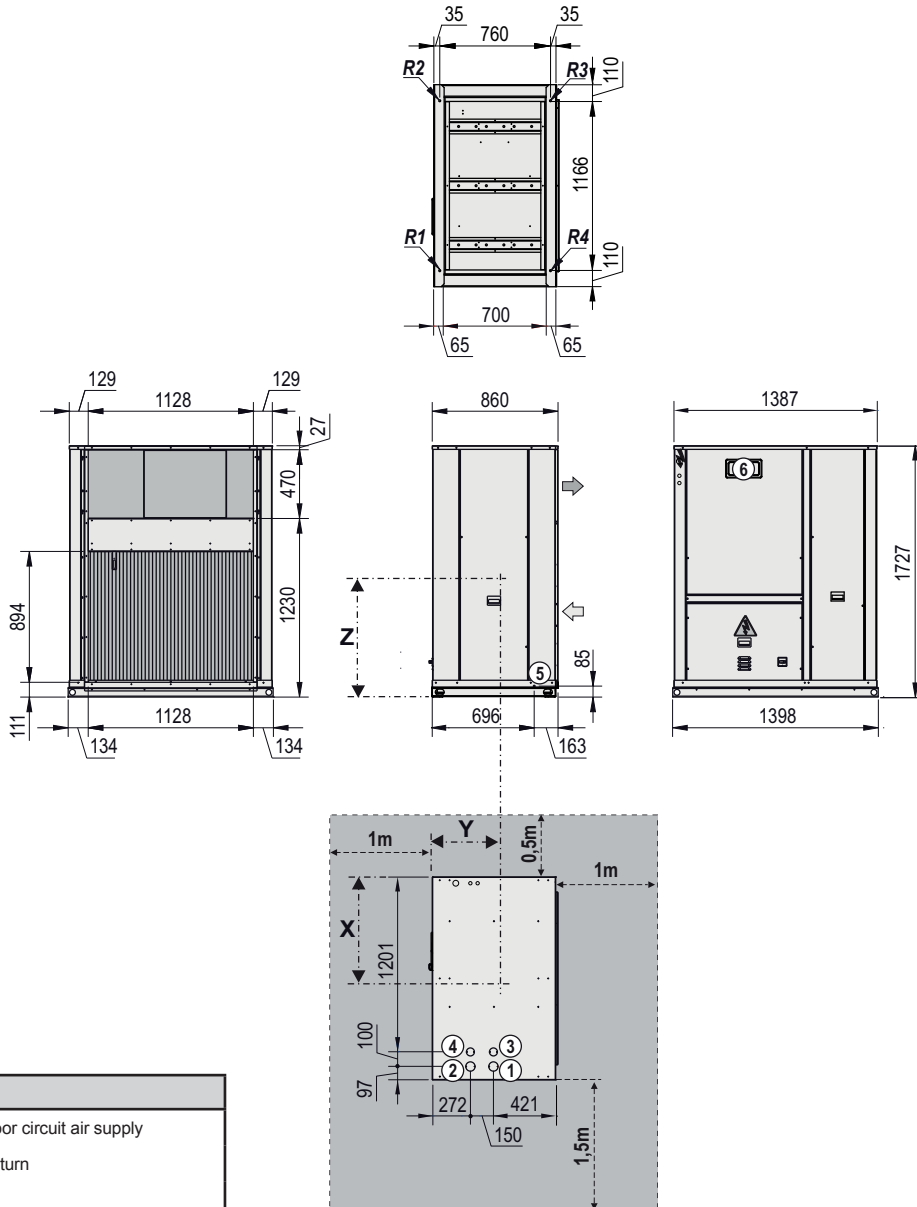

Clear space to be observed for maintenance operations and unit start-up

Models		Centre of gravity coordinates (mm)			Reactions in the supports (kg)				
		X	Y	Z	Weight	R1	R2	R3	R4
30PA/PH	90HEE	502	422	614	298	64	100	85	50
30PAC/PHC	90HEE	538	427	599	327	77	84	87	79

DIMENSION SCHEMES FOR THE HEE VERSION

30PA/PH/PAC/PHC - 100HEE / 120HEE with HORIZONTAL supply, M00 assembly (mm)



LEGEND	
	HORIZONTAL outdoor circuit air supply
	Outdoor circuit air return
	Electric panel
	Electric power supply
	Door switch
①	Water inlet to the indoor circuit
②	Water outlet from the indoor circuit
③	Water outlet from the recovery circuit (optional)
④	Water inlet to the recovery circuit (optional)
⑤	Condensate outlet: trunk 3/4" M
⑥	Collapsible window for access to control panel (it protrudes 12 mm)
Note: the hydraulic connections ①② protrude 58 mm	
Anti-vibration anchoring: rivet nut M10	
 Clear space to be observed for maintenance operations and unit start-up	

Models	Centre of gravity coordinates (mm)			Reactions in the supports (kg)					
	X	Y	Z	Weight	R1	R2	R3	R4	
30PA 30PH	100HEE	569	417	673	358	63	127	116	52
	120HEE	628	426	742	376	88	112	100	77
30PAC 30PHC	100HEE	638	418	623	390	88	109	107	86
	120HEE	696	427	674	408	100	101	104	103

DIMENSION SCHEMES FOR THE HEE VERSION

30PA/PH/PAC/PHC - 100HEE / 120HEE with VERTICAL supply, M01 assembly (mm)

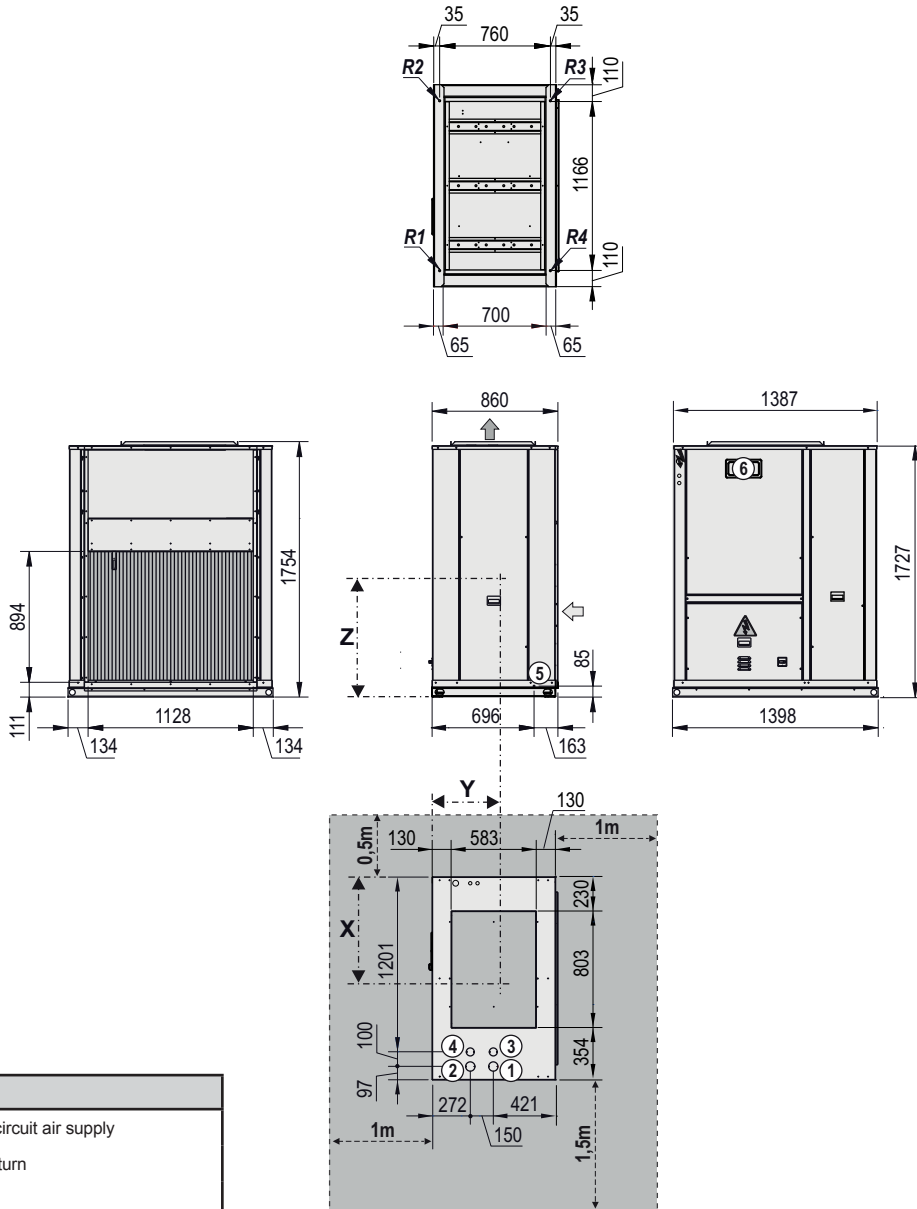

LEGEND

- VERTICAL outdoor circuit air supply
- Outdoor circuit air return
- Electric panel
- Electric power supply
- Door switch
- ① Water inlet to the indoor circuit
- ② Water outlet from the indoor circuit
- ③ Water outlet from the recovery circuit (optional)
- ④ Water inlet to the recovery circuit (optional)
- ⑤ Condensate outlet: trunk 3/4" M
- ⑥ Collapsible window for access to control panel (it protrudes 12 mm)

Note: the hydraulic connections ①② protrude 58 mm

Anti-vibration anchoring: rivet nut M10

Clear space to be observed for maintenance operations and unit start-up

Models		Centre of gravity coordinates (mm)			Reactions in the supports (kg)				
		X	Y	Z	Weight	R1	R2	R3	R4
30PA 30PH	100HEE	569	417	673	358	63	127	116	52
	120HEE	628	426	742	376	88	112	100	77
30PAC 30PHC	100HEE	638	418	623	390	88	109	107	86
	120HEE	696	427	674	408	100	101	104	103

DIMENSION SCHEMES FOR THE HEE VERSION

30PA/PH/PAC/PHC - 160HEE / 180HEE with HORIZONTAL supply, M00 assembly (mm)

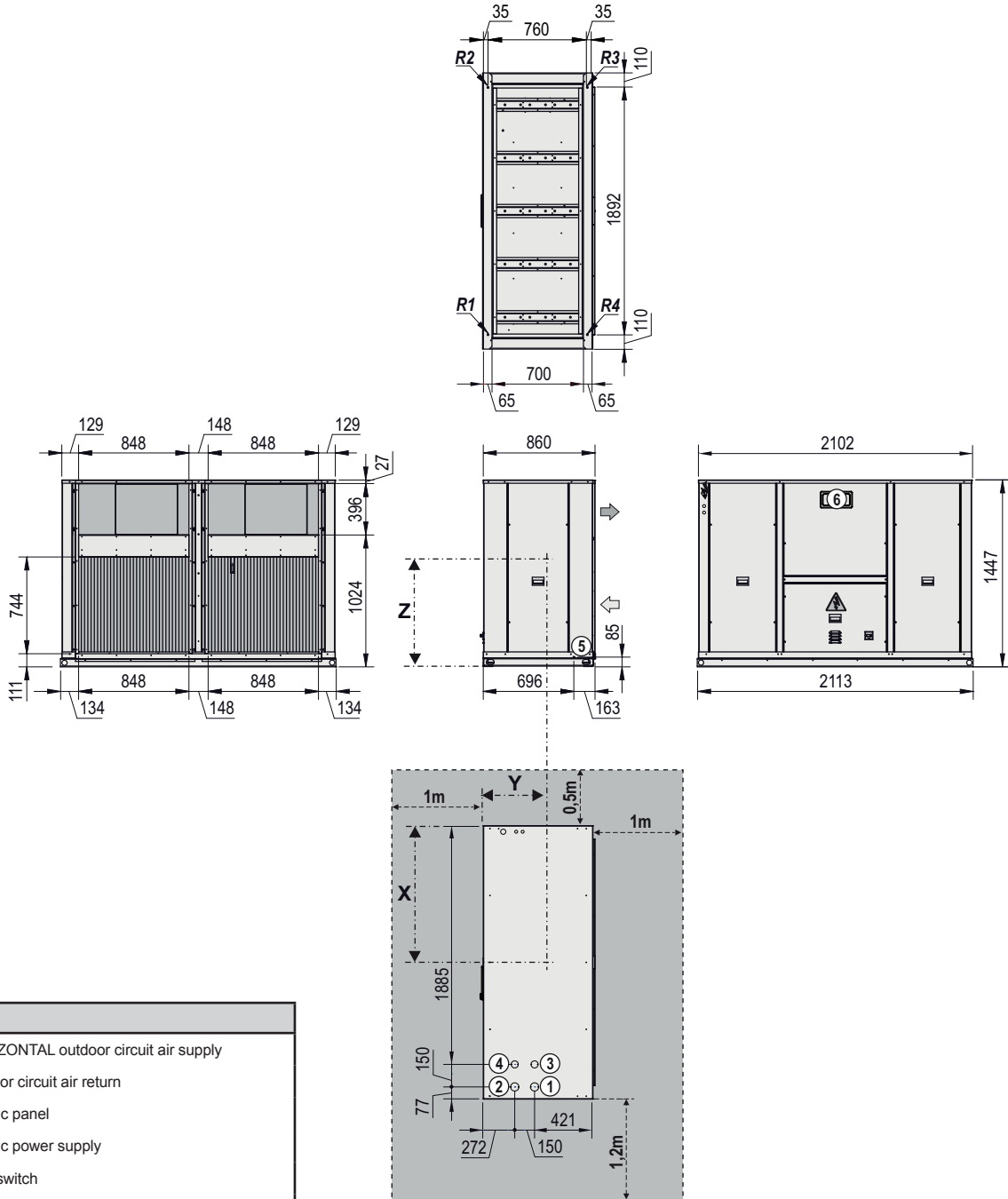

LEGEND

- HORIZONTAL outdoor circuit air supply
- Outdoor circuit air return
- Electric panel
- Electric power supply
- Door switch
- ① Water inlet to the indoor circuit
- ② Water outlet from the indoor circuit
- ③ Water outlet from the recovery circuit (optional)
- ④ Water inlet to the recovery circuit (optional)
- ⑤ Condensate outlet: trunk 3/4" M
- ⑥ Collapsible window for access to control panel (it protrudes 12 mm)

Note: the hydraulic connections ①② protrude 58 mm

Anti-vibration anchoring: rivet nut M10

Clear space to be observed for maintenance operations and unit start-up

Models		Centre of gravity coordinates (mm)			Reactions in the supports (kg)				
		X	Y	Z	Weight	R1	R2	R3	R4
30PA 30PH	160HEE	940	435	573	465	69	177	163	56
	180HEE	936	434	579	468	71	178	163	56
30PAC 30PHC	160HEE	975	436	570	497	109	130	140	118
	180HEE	972	436	575	503	110	132	142	119

DIMENSION SCHEMES FOR THE HEE VERSION

30PA/PH/PAC/PHC - 160HEE / 180HEE with VERTICAL supply, M01 assembly (mm)

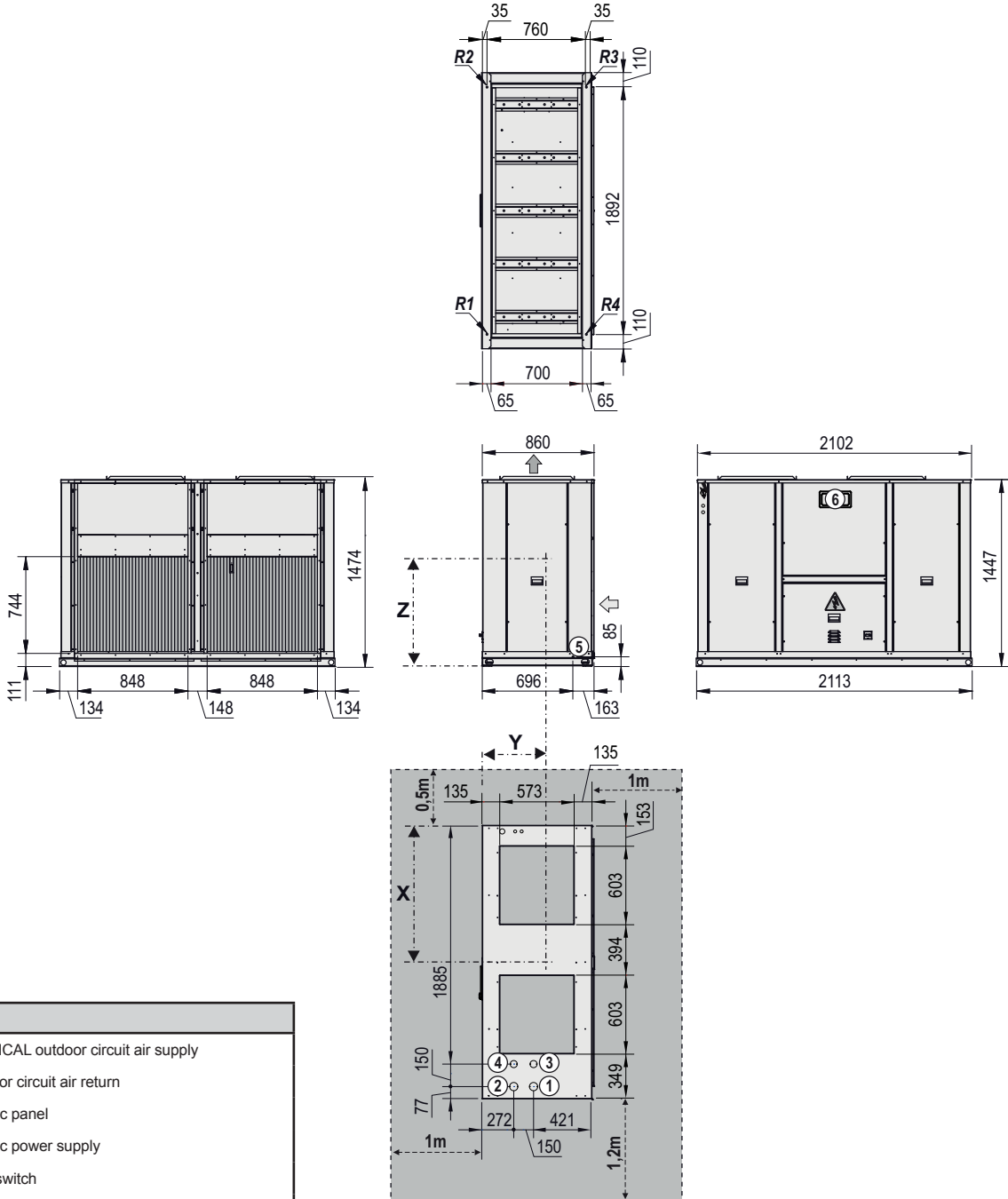

LEGEND

- VERTICAL outdoor circuit air supply
- Outdoor circuit air return
- Electric panel
- Electric power supply
- Door switch
- ① Water inlet to the indoor circuit
- ② Water outlet from the indoor circuit
- ③ Water outlet from the recovery circuit (optional)
- ④ Water inlet to the recovery circuit (optional)
- ⑤ Condensate outlet: trunk 3/4" M
- ⑥ Collapsible window for access to control panel (it protrudes 12 mm)

Note: the hydraulic connections ①② protrude 58 mm

Anti-vibration anchoring: rivet nut M10

Clear space to be observed for maintenance operations and unit start-up

Models		Centre of gravity coordinates (mm)			Reactions in the supports (kg)				
		X	Y	Z	Weight	R1	R2	R3	R4
30PA 30PH	160HEE	940	435	573	465	69	177	163	56
	180HEE	936	434	579	468	71	178	163	56
30PAC 30PHC	160HEE	975	436	570	497	109	130	140	118
	180HEE	972	436	575	503	110	132	142	119

DIMENSIONS OF AIR FLEXIBLE DUCTS (OPTION)

Supply ducts

STD version	Dimensions (mm)			Weight (kg)
	A	B	C	
M00 assembly without damper ①				
90STD / 100STD	859	407	132	4
120STD / 160STD / 180STD	1139	481	132	5
M00 assembly with damper ①				
90STD / 100STD	859	407	132	4
120STD / 160STD / 180STD	1139	481	132	5
M01 assembly without damper ①				
90STD / 100STD	552	430	152	4
120STD / 160STD / 180STD	652	552	152	5
M01 assembly with damper ①				
90STD / 100STD	513	391	132	4
120STD / 160STD / 180STD	613	513	132	5

HEE version	Dimensions (mm)			Weight (kg)
	A	B	C	
M00 assembly				
90HEE	859	407	132	4
100HEE / 120HEE	1139	481	132	5
160HEE / 180HEE	1854	407	132	7
M01 assembly				
90HEE	633	589	132	4
100HEE / 120HEE	817	639	132	5
160HEE / 180HEE	1619	590	132	7

Return ducts

STD version	Dimensions (mm)			Weight (kg)
	C	D	E	
Assembly without filters				
90STD / 100STD	132	903	800	5
120STD / 160STD / 180STD	132	1183	950	7
Assembly with filters				
90STD / 100STD	109	903	800	5
120STD / 160STD / 180STD	109	1183	950	7

HEE version	Dimensions (mm)			Weight (kg)
	C	D	E	
Assembly without filters				
90HEE	132	903	800	5
100HEE / 120HEE	132	1183	950	7
160HEE / 180HEE	132	1897	800	8
Assembly with filters				
90HEE	109	903	800	5
100HEE / 120HEE	109	1183	950	7
160HEE / 180HEE	109	1897	800	8

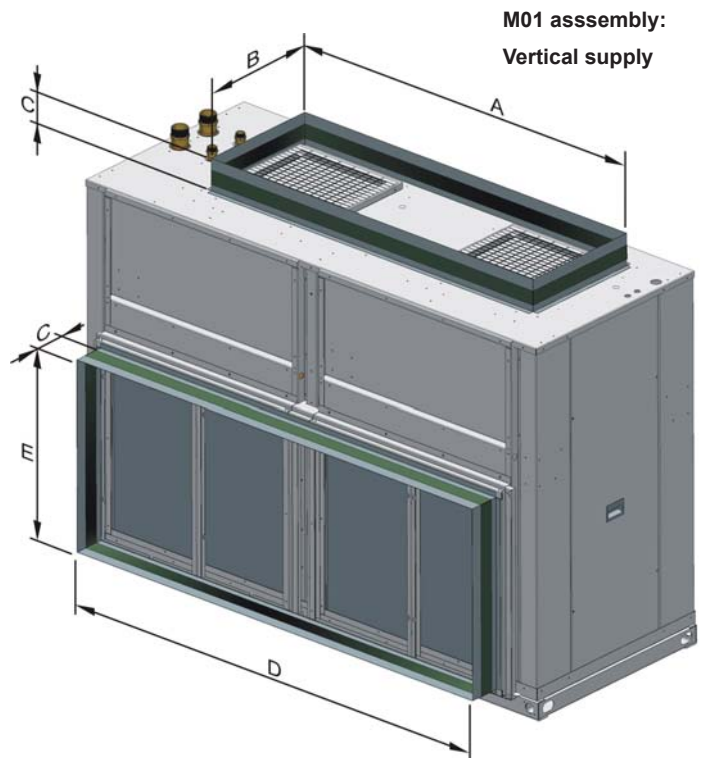
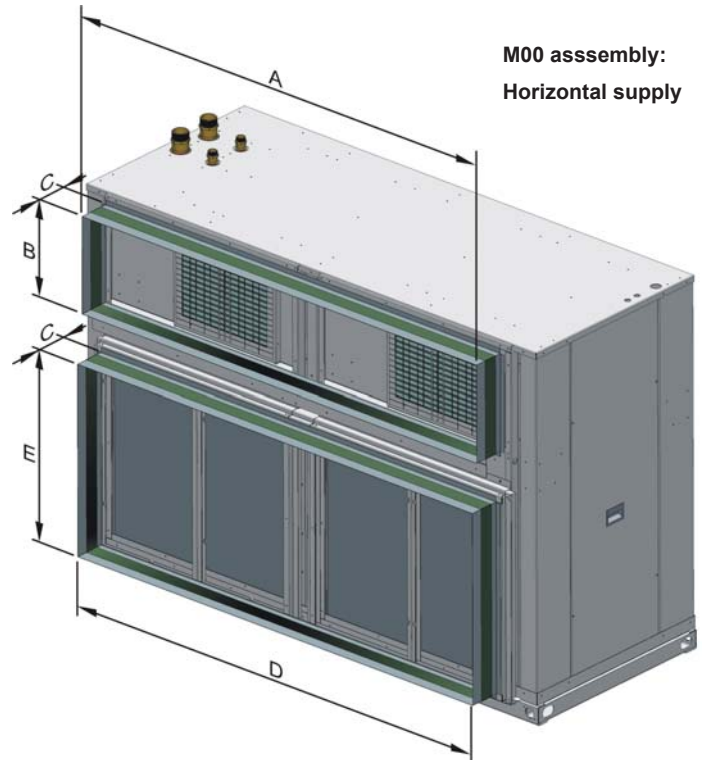

① Damper for condensation pressure control (optional): add the height of the damper to the flexible duct.

GRAVIMETRIC FILTERS IN THE RETURN AIR (OPTION)

Air pressure drop

30PA/PH/PAC/PHC	Nominal air flow (m ³ /h)	Pressure drop (mm.w.c.)
90STD	6500	4,9
100STD	7000	5,7
120STD	10000	4,6
160STD / 180STD	12200	6,8

30PA/PH/PAC/PHC	Nominal air flow (m ³ /h)	Pressure drop (mm.w.c.)
90HEE	6500	4,9
100HEE	7000	2,2
120HEE	10000	4,6
160HEE	12200	4,3
180HEE	14000	5,7

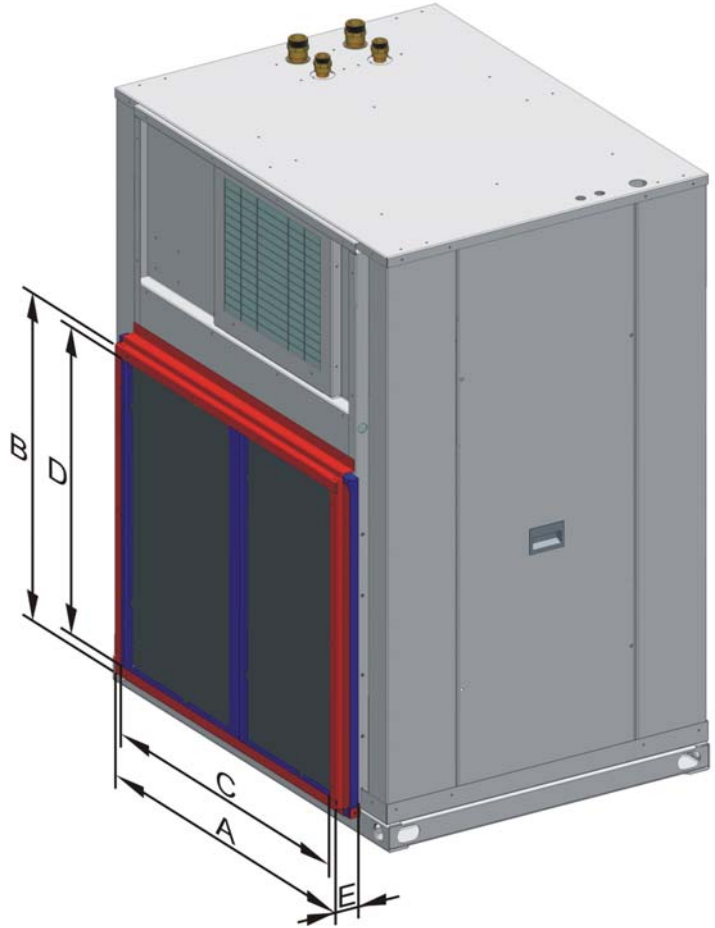

Dimensions (mm)

30PA/PH/PAC/PHC	Frames number	Frame dimensions (mm)					Distance between frames (mm)	Cells number	Cell thickness (mm)	Cell size (mm)	Total weight (mm)
		A	B	C	D	E					
90STD / 100STD	1	896	795	848	744	53	---	2	25	818 x 468	6
120STD / 160STD / 180STD	1	1176	945	1128	894	53	---	3	25	968 x 405	8

30PA/PH/PAC/PHC	Frames number	Frame dimensions (mm)					Distance between frames (mm)	Cells number	Cell thickness (mm)	Cell size (mm)	Total weight (mm)
		A	B	C	D	E					
90HEE	1	896	795	848	744	53	---	2	25	818 x 468	6
100HEE / 120HEE	1	1176	945	1128	894	53	---	3	25	968 x 405	8
160HEE / 180HEE	2	896	795	848	744	53	100	4	25	818 x 468	12

Filters frame is removable, and on request, can be supplied separate from the unit for connection on site.



Ductable air-cooled scroll chillers and heat pumps

AIRFLOW CHARACTERISTICS: SELECTION OF FAN MOTORS

STD version:

Centrifugal fan coupling by pulleys and belts

30PA 30PH 30PAC 30PHC	Nominal air flow (m ³ /h)	Available pressure (mm.w.c)	Motor output (kW)	Power input (kW)	Fan speed (r.p.m.)	Code
90STD	6500	7	1,5	1,16	821	OPK0337
		10	1,5	1,22	856	OPK0337
		15	1,5	1,33	915	OPK0048
		20	2,2	1,46	973	OPK0512
		25	2,2	1,58	1030	OPK0363
		30	2,2	1,72	1087	OPK0509
		35	--	--	--	--
100STD	7000	7	2,2	1,44	886	OPK0513
		10	2,2	1,52	919	OPK0513
		15	2,2	1,64	973	OPK0512
		20	2,2	1,77	1027	OPK0363
		25	3,0	1,90	1081	OPK0370
		30	3,0	2,05	1134	OPK0354
		35	3,0	2,19	1186	OPK0369
120STD	10000	7	2,2	1,90	723	OPK0408
		10	3,0	2,00	750	OPK0415
		15	3,0	2,16	794	OPK0385
		20	3,0	2,33	837	OPK0387
		25	3,0	2,50	880	OPK0386
		30	4,0	2,68	923	OPK0388
		35	4,0	2,87	965	OPK0388
160STD	12200	7	3,0	2,22	627	OPK0190
		10	3,0	2,35	652	OPK0397
		15	4,0	2,59	694	OPK0198
		20	4,0	2,83	734	OPK0399
		25	4,0	3,07	773	OPK0197
		30	4,0	3,32	812	OPK0197
		35	5,5	3,59	849	OPK0547
180STD	12200	7	3,0	2,22	627	OPK0190
		10	3,0	2,35	652	OPK0397
		15	4,0	2,59	694	OPK0198
		20	4,0	2,83	734	OPK0399
		25	4,0	3,07	773	OPK0197
		30	4,0	3,32	812	OPK0197
		35	5,5	3,59	849	OPK0547

HEE version:

Electronic plug-fan

30PA 30PH 30PAC 30PHC	Nominal air flow (m ³ /h)	Available pressure (mm.w.c)	Motor output (kW)	Power input (kW)	Fan speed (r.p.m.)
90HEE	6500	7	2,7	1,00	1240
		10	2,7	1,07	1266
		15	2,7	1,19	1309
		20	2,7	1,33	1352
		25	2,7	1,46	1392
		30	2,7	1,60	1434
		35	2,7	1,73	1475
100HEE	7000	7	2,8	0,87	1220
		10	2,8	0,95	1247
		15	2,8	1,07	1292
		20	2,8	1,21	1344
		25	2,8	1,33	1388
		30	2,8	1,48	1435
		35	2,8	1,62	1476
120HEE	10000	7	3,0	1,41	1225
		10	3,0	1,50	1243
		15	3,0	1,67	1276
		20	3,0	1,87	1307
		25	3,0	2,04	1343
		30	3,0	2,23	1378
		35	3,0	2,42	1413
160HEE	12200	7	2 x 3,0	2 x 0,77	937
		10	2 x 3,0	2 x 0,85	969
		15	2 x 3,0	2 x 0,98	1022
		20	2 x 3,0	2 x 1,10	1072
		25	2 x 3,0	2 x 1,27	1122
		30	2 x 3,0	2 x 1,42	1172
		35	2 x 3,0	2 x 1,58	1220
180HEE	14000	7	2 x 3,0	2 x 0,88	991
		10	2 x 3,0	2 x 0,96	1020
		15	2 x 3,0	2 x 1,11	1070
		20	2 x 3,0	2 x 1,26	1117
		25	2 x 3,0	2 x 1,41	1163
		30	2 x 3,0	2 x 1,57	1209
		35	2 x 3,0	2 x 1,73	1249



Ductable air-cooled scroll chillers and heat pumps

ASSEMBLY RECOMMENDATIONS



It is mandatory to follow the recommendations and instructions in the user's brochure for installation, commissioning, operation, and maintenance (No 10057).

Lifting and handling operations

The lifting and handling operations must be done in safe conditions.

Accurately follow the lifting plan present in the unit and in the user's brochure for installation, commissioning, operation, and maintenance.

Before beginning the handling, carefully check that there is sufficient access space so that the unit can enter into the facility.

Maintenance must be done only while vertical, which is why the unit must not be laid or turned horizontally.

Location

The 30PA/PH/PAC/PHC air-cooled chillers and heat pumps are ductable units to be installed indoors.

Clear space must be planned around the unit (indicated on the dimensions schemes) for maintenance operations and normal operation. No obstacle may impede the air aspiration into the coil or make the outlet of the fan difficult.

The unit's location must be carefully studied. A suitable positioning must be selected in accordance with the demands of the surroundings (integration in the environment, noise emission, etc.) and where only authorised persons have access.

According to the guidelines in place in the place of installation, certain new air ventilation standards must be respected so as not to cause any discomfort or danger in the case of refrigerant fluid leakage.

In the event of connection by pipes, study the network carefully (flows, pressure drops, speeds, etc.). A poorly studied network (excessive speeds, poor stiffness, etc.) can cause a significant sound level.

30PA/PH/PAC/PHC units must have the ducted supply. The weight of an air discharge duct must not rest on the unit at any time.

The pipe must ensure that the people in front of the fan are protected.

In particular, avoid installing the units in areas where those under the age of 14 could come into contact with them. If necessary, access to the units will be protected using a suitable enclosure or fencing.

All of the units are fully charged with refrigerant and tested in the factory.

Safety devices

The units have the necessary control and safety elements; cold water temperature controlling, water circulation controller, anti-freeze safety, high- and low-pressure pressostats, anti-short-cycle timing, compressor and ventilator thermal protection, etc.

Electrical connections

The indications required for the electrical connections are indicated on the electrical diagram enclosed with the unit.

These connections are always established as per the norms in force. The electric and control panel is completely wired. Only the main electric power supply has to be set up (the engineer must plan for the protections: main switch, differential switch, etc.).

The installer must perform a command remotely from the unit and have operation and failure indicators.

Plan a switch for selecting the operation mode (cooling-heating) for the reversible units.

It is important to remember that the unit is not protected against radiation, from the electrical point of view. Therefore, safety devices to protect against these temporary phenomena must be placed in the installation and incorporated into the electrical supply panel.

Water quality criteria

Warning: During installation, it is mandatory that an 500 micron water be placed in the unit's water inlet.

The proper and suitable operation of a cold/hot water production unit with a respectable useful life depends directly on the quality of the water used, particularly if the water can cause phenomena such as clogging, corrosion, formation of algae or micro-organisms.

It is mandatory to analyse the water in order to verify that it can be used in the unit and to determine whether a chemical treatment will be sufficient to confer an acceptable quality level or whether a softening and demineralisation system is necessary.

This analysis must confirm whether or not the water present in the work is compatible with the following nomenclature for the various materials present in the 30PA/PH/PAC/PHC unit circuit:

- 99.9% copper tubes with copper and silver welding.
- Bronze threaded hoses.
- AISI 316 - 1.4401 stainless steel plate exchangers and connections with copper and silver welding.

Warning: If these instructions are not respected, the unit's warranty shall lose its validity.



Ductable air-cooled scroll chillers and heat pumps

Hydraulic connections

The direction of water circulation must be observed as indicated on the unit.

Plan the anti-freeze protection for the unit and the installation when the outdoor temperature is low and the unit does not function: water with anti-freeze, draining the installation, etc.

In installations to open circuits, if it is not possible to maintain the water conditions within the values indicated in the corrosion behaviour table, it will be necessary to install an exchanger that separates the unit circuit from the circuit of the water circuit to be dealt with by using materials compatible with these characteristics, whether stainless steel or titanium.

The tubes must not transmit any force or vibrations to the water exchanger. It is advisable to use flexible hoses for connecting the piping to the unit in order to reduce the transmission of vibrations to the building to the greatest degree. It is mandatory to assemble hoses if the unit is installed over antivibration mounts.

Hydraulic circuit

All essential accessories for the hydraulic circuits must be planned (expansion vessel, air bleeder valves, safety valve, cut-off valve, drainage holes, thermometers, etc.).

Check the water content of the installation, if necessary, to plan a buffer tank.

It is also necessary to install a filter (supplied in the 30PAC/PHC kit) in the hydraulic power supply to the unit (for particulates of $\varnothing < 500$ microns) in order to prevent clogging of the plate exchanger (this can cause a decrease in flow that could lead to freezing and breaking the exchanger).

Warnings:

- Ensure that the pressure of the water circuits is below 4.0 bars.
- Place the expansion vessel in front of the pump.
- Do not assembly any valve on the expansion vessel.
- Ensure that the water circulation pumps are located in the entrance of the plate exchangers.
- Ensure that the water pressure in the aspiration of the circulation pumps is equal to or greater than the minimum nominal pressure (NPSHR), particularly in the case of an "open" hydraulic circuit.
- Analyse the water quality criteria in accordance with the technical recommendations.
- Plan the anti-freeze protections that the unit and the hydraulic installations need, such as the possibility of purging the circuit. In the presence of glycol for anti-freeze protection, it is mandatory to supervise its nature and concentration prior to commissioning.
- Before making the final hydraulic connections, rinse the tubes with clean water to remove impurities.

Commissioning

Non-exhaustive list of operations that must be performed during commissioning:

- Check for the proper installation of the unit.
- Check for electrical power supply protection.
- Check for phases and the direction of rotation.
- Verification of the electronic wiring of the unit.
- Check of the water circulation direction in the unit.
- Verification of the cleanliness of the hydraulic circuit.
- Control of the water flow according to the specified value.
- Check of the cooling circuit pressures.
- Verification of the rotation direction of the compressors.
- Check of the pressure drops and the water flow drops.
- Report on the operating values.

Problems in commissioning

Problems could occur during the start of the units' operation if the conditions under which the start is performed are not suitable:

- Insufficient water flow. Very high temperature differences between water inlet into and outlet from the unit caused by:
 - Insufficient air bleeding.
 - Small water circulation pump or anti-clockwise rotation.
 - Other situations which may prevent correct water circulation.
- Insufficient thermal charge in the installation. The limiting operating values are quickly reached by:
 - Incorrect operation of the emissions system (fan coils, air conditioning exchangers, etc.).
- Air recirculation in the unit caused by an obstacle in the air aspiration or in its outlet.

To prevent such problems, the electric and hydraulic connections must be verified prior to starting the unit, checking the correct operation of the water circulation pump, the filling and draining of the hydraulic circuit, etc.

It is necessary to maintain the main electric supply to the unit for 24 hours before starting it so that the compressor's crankcase heater may start.

When the unit is operating, its main power supply must not be cut. The shutdown must be done from a remote command. The crankcase heater must always be with voltage (except for prolonged shut-downs of the unit).

Note: Check that the water flow in the circuit is constant and sufficient (see evaporator operation limit). In case there should be a variation in the flow (control by two-way valves, closing and opening circuits), it is necessary to assemble a pressure differential valve or circulation pumps on each circuit.



Order No.: 10056, 06.2016. Supersedes order No.: 08.2015
The manufacturer reserves the right to change the specification without prior notice.



ISO-9001

Manufactured for CARRIER in Spain.
Printed in the European Union.